



LARGE HORIZONTAL TURNING CENTERS WITH
2-AXIS TO Y-AXIS MACHINING CAPABILITIES

PUMA

600II • 700II • 800II



PUMA 600/700/800II SERIES

PUMA 600/700/800 II machines are large horizontal turning centers ideal for machining pipes, valves and flanges used in oil and gas industry, hydraulic parts used in construction equipment, and also complex parts used in the aircraft and ship building industries. Maximum turning diameters and lengths are $\varnothing 900\text{mm}$ (35.4inch) and 5050mm (198.8inch) respectively, which are the highest in their class. The slant bed design allows easy chip disposal.



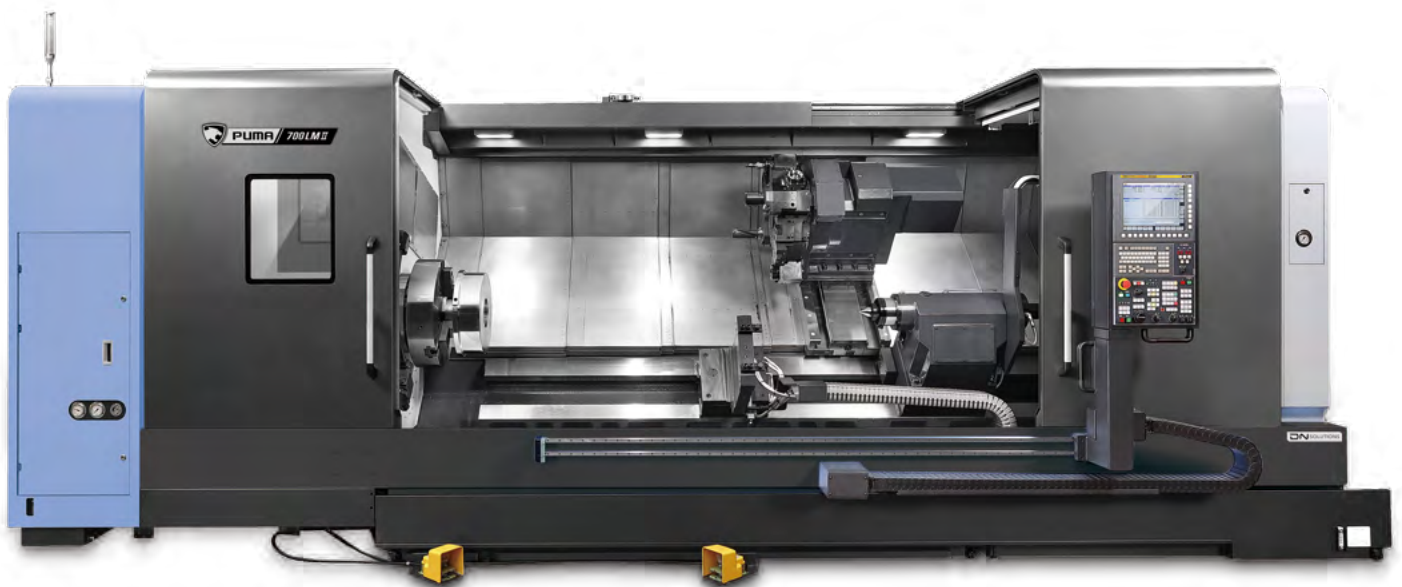

SINGLE SETUP FOR MACHINING LARGE COMPLEX PARTS

- Maximum productivity can be achieved with the machines' 200mm (7.9inch) ($\pm 100\text{mm}$ (3.9inch)) orthogonal Y-axis structure, which allows users to machine a wide range of large and complex parts.

THE LARGEST MACHINING AREA AND TOP PERFORMANCE IN ITS CLASS

- With 5m maximum turning length, $\text{\O}900\text{mm}$ (35.4inch) maximum turning diameter and $11004\text{N}\cdot\text{m}$ (8121.0ft-lbs) of Torque, the machines are ideal for the heavy-duty cutting of large parts used in many different industries.
- CAPTO type ATC(Auto Tool Changer) increases the number of tooling options, reduces setup times and is suitable for machining hard-to-cut materials (Titanium, Inconel etc.). **OPTION**

THE SOLUTION FOR MACHINING A WIDE RANGE OF PIPES

- $\text{\O}375\text{mm}$ (14.8inch) maximum spindle through hole diameter makes the machines ideal for turning large diameter pipes.
- The machines take the machining of high-accuracy and performance-critical threads in their stride.

BASIC STRUCTURE

Machine capabilities range from 2-axis to Y-axis, which enables large diameter parts to be set up and machined in a single operation.



Series	Chuck* Size (inch)	1600 mm (63 inch)_Std.			3200 mm (126 inch)_L			5050 mm (199 inch)_XL		
		2-axis	M	Y	2-axis	M	Y	2-axis	M	Y
PUMA 600 II	18	○	○	-	○	○	○	○	○	○
PUMA 700 II	24	○	○	-	○	○	○	○	○	○
PUMA 800 II	32	○	○	-	○	○	○	○	○	○
PUMA 800B II	Order made	○	-	-	○	-	-	-	-	-

* Chuck and chuck cylinder are optional features.

SPINDLE

The gearbox design allows the PUMA 600/700/800 II spindles to have unparalleled power and torque, which boosts productivity and delivers extreme heavy-duty cutting capability.

Max. spindle speed

750 r/min

Max. spindle power

55{**75** OPTION} kW

73.8 {100.1} Hp

Max. spindle torque

8076 {**11013** OPTION} N·m

5960.1 {8127.6} ft-lbs

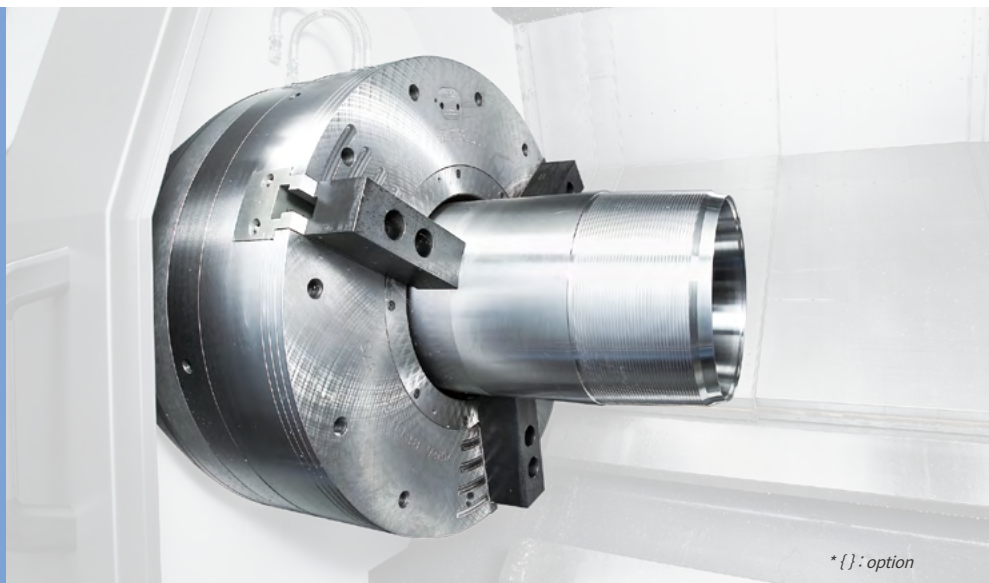

* {} : option

Series	Max. spindle speed (r/min)	Max. spindle power (kW (Hp))	Max. spindle torque (N·m (ft-lbs))
PUMA 600 II	1800	55 {75} (73.8 {100.6})	6622 {9030} (4887.0 {6664.1})
PUMA 700 II	1500		8076 {11013} (5960.1 {8127.6})
PUMA 800 II	750		
PUMA 800B II	500		

MACHINING AREA

The largest work envelope in their class with a maximum turning diameter of Ø900mm(35.4inch) and maximum turning length of 5m.

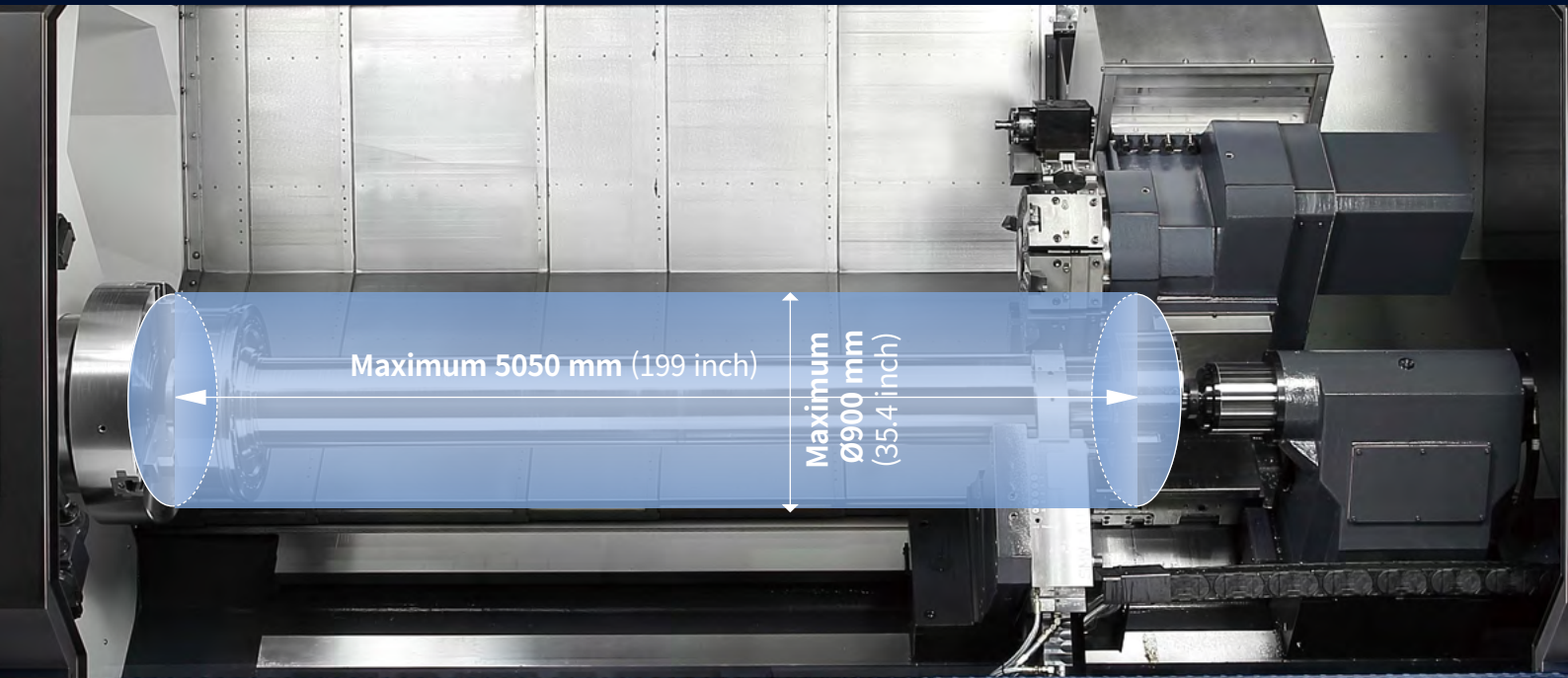

Unit: mm (inch)

Max. turning diameter

Ø 900 mm
35.4 inch

Max. turning length

5050 mm
199 inch

	Series	Max. turning diameter	Max. turning length
2-axis	PUMA 600 /700/800/800B II	900 (35.4)	1600 (63)
	PUMA 600L/700L/800L/800LB II		3200 (126)
	PUMA 600XL/700XL/800XL II		5050 (199)
M	PUMA 600M/700M/800M II	750 (29.5)	1600 (63)
	PUMA 600LM/700LM/800LM II		3200 (126)
	PUMA 600XLM/700XLM/800XLM II		5050 (199)
Y	PUMA 600LY/700LY/800LY II	750 (29.5)	3250 (128)
	PUMA 600XLY/700XLY/800XLY II		5050 (199)

Machines are available with various spindle-through-hole sizes to provide the optimum machining solutions for different sized pipes.

Max. spindle through hole diameter

Ø375 mm
14.8 inch

Series	Max. spindle through hole diameter (mm (inch))
PUMA 600 II	152 (6.0)
PUMA 700 II	181 (7.1)
PUMA 800 II	320 (12.6)
PUMA 800B II	375 (14.8)

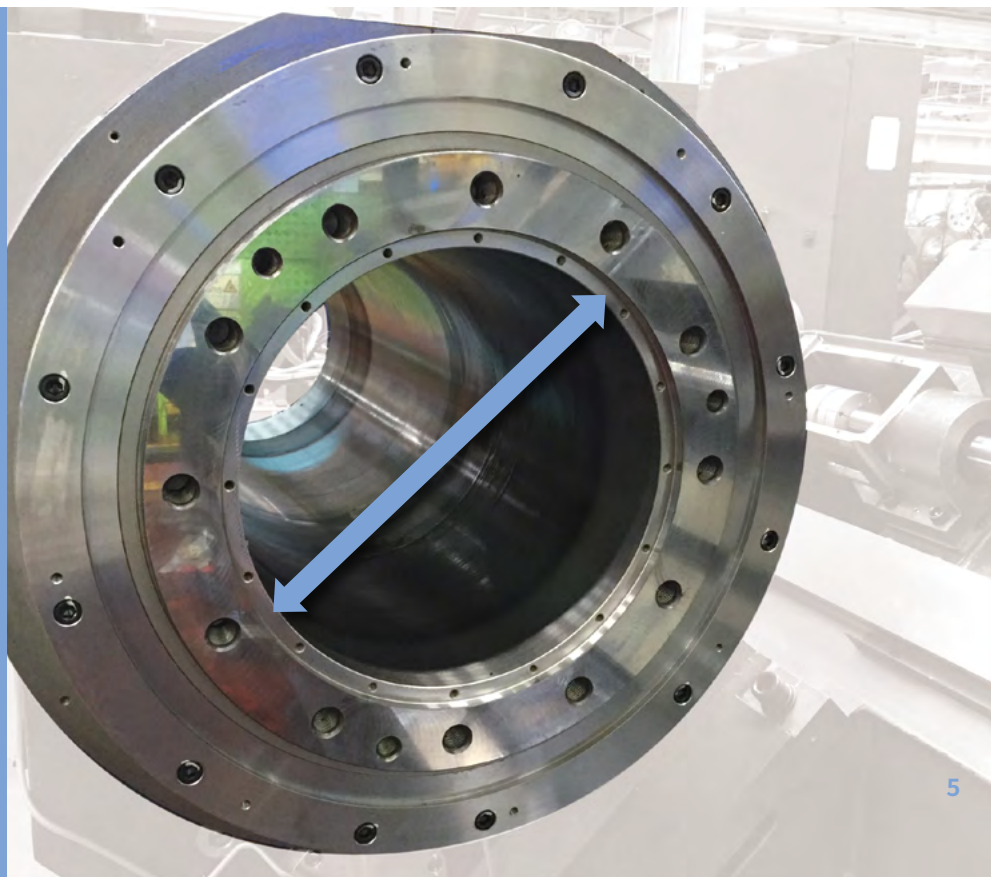

TAILSTOCK

The standard programmable tailstock is easy to position and adjust thereby helping to reduce set up times.

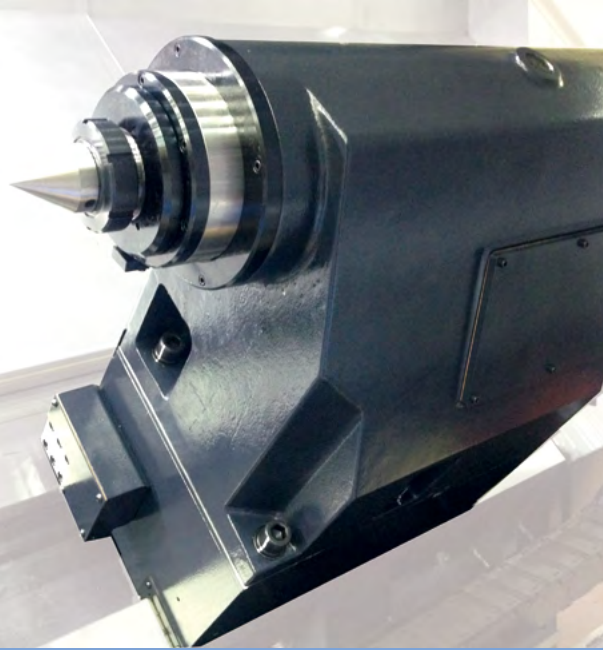

Unit : mm (inch)

Series	Quill diameter	Quill travel
PUMA 600/M/L/LM II	160 (6.3)	150 (5.9)
PUMA 700/M/L/LM II		
PUMA 800/M/L/LM II		
PUMA 600LY/XL/XLM/XLY II	180 (7.1)	150 (5.9)
PUMA 700LY/XL/XLM/XLY II		
PUMA 800LY/XL/XLM/XLY II		
PUMA 800B/LB II	160 (6.3)	150 (5.9)

Tailstock travel

1550 mm
61 inch

3135 mm* (L)
123 inch

4885 mm (XL)
192 inch

TURRET

DN Solutions's uniquely-designed BMT85P turret is used on M- and Y-Axis models to boost heavy-duty cutting performance.

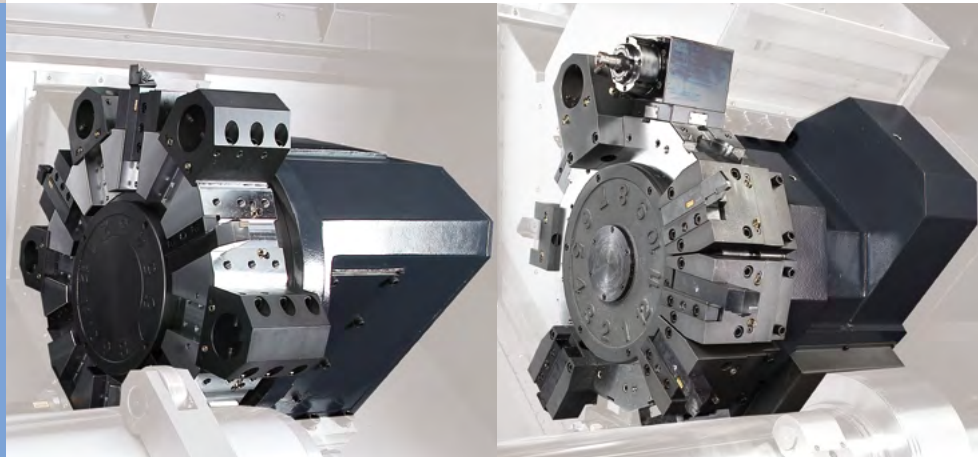

2-axis model

No. of tool stations

12 ea

M/Y Model

BMT85P

No. of tool stations

12 ea

AUTOMATIC TOOL CHANGER

OPTION

Capto Tools in the ATC deliver higher productivity when machining difficult to cut materials.

Description	Spec.
MAGAZINE & ATC	
Tool shank	CAPTO C8
Tool storage capa.	6 ea
Max. tool diameter	Ø80 mm
Max. tool length	320mm (400mm*) (12.6 (15.7inch*))
Max. tool weight	10 kg (22.0lb)
Magazine motor	Servo

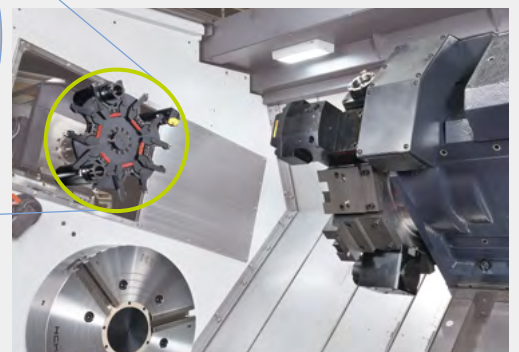

CUTTING PERFORMANCE

PUMA 600/ 700/800 II machines can perform high-productivity, heavy-duty machining operations such as ID/OD turning, end milling, tapping and U-drilling etc.



O.D turning (Material diameter Ø 380 mm)	
Speed	230 m/min (9055.1 ipm)
Feed	0.6 mm/rev (0.0 ipr)
Depth of cut	10 mm (0.4 inch)
Chip Removal rate	1418 cm ³ /min (86.5 inch ³ /min)

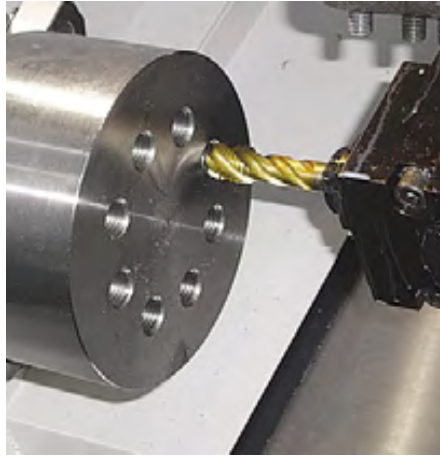

Tapping	
Cutting Tool	M33 x P3.5
Cutting speed	15 m/min (590.6 ipm)
Feed	3.5 mm/rev (0.1 ipr)



U-Drill (3-axis)	
Cutting Tool	Ø 30 mm (1.2 inch)
Spindle Load	2000 m/min (7874.0 ipm)
Feed	0.12 mm/rev (0.0 ipr)
Chip Removal rate	171 cm ³ /min (10.4 inch ³ /min)

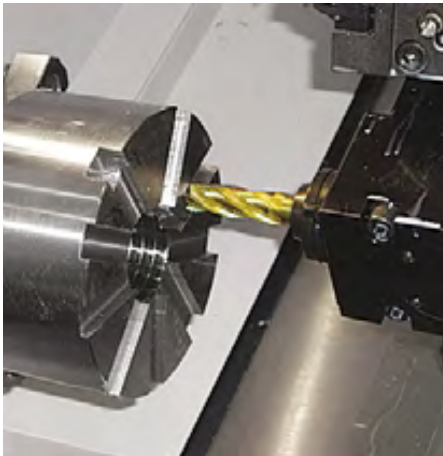

End mill (Low Speed)	
Cutting Tool	Ø 32 mm (1.3 inch)
Spindle Load	30 m/min (1181.1 ipm)
Feed	90 mm/min (3.5 ipm)
Chip Removal rate	105 cm ³ /min (6.4 inch ³ /min)

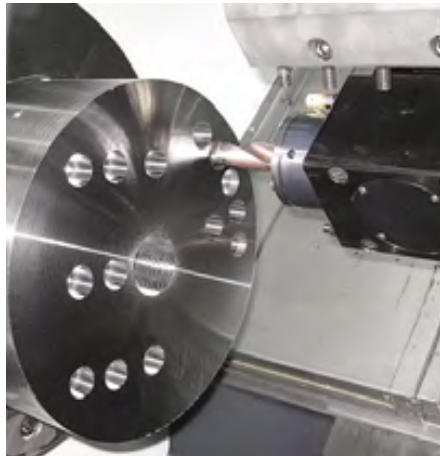

End mill (High Speed)	
Cutting Tool	Ø 25 mm (1.0 inch)
Spindle Load	220 m/min (8661.4 ipm)
Feed	1000 mm/min (39.4 ipm)
Chip Removal rate	175 cm ³ /min (10.7 inch ³ /min)



Helical End Milling	
Cutting Tool	Ø 25 mm (1.0 inch)
Spindle Load	240 m/min (9448.8 ipm)
Feed	800 mm/min (31.5 ipm)
Chip Removal rate	100 cm ³ /min (6.1 inch ³ /min)

* The results, indicated in this catalogue are provided as examples only. They may not always be obtained due to differences in cutting and environmental conditions.

STANDARD & OPTIONAL SPECIFICATIONS

Diverse optional features are available for customer-specific work applications.

Description	Features	PUMA 600 II series		PUMA 700 II series		PUMA 800 II series				
		2-axis / M	Y	2-axis / M	Y	2-axis / M	Y	Big bore (B/LB)		
Chuck	None	●	●	●	●	●	●	●		
	18 inch	○	○	X	X	X	X	X		
	21 inch	○	○	X	X	X	X	X		
	24 inch	X	X	○	○	X	X	X		
	32 inch	X	X	X	X	○	○	X		
	32INCH (OUT DIAMETER Ø800)	○	○	○	○	X	X	X		
	40INCH (OUT DIAMETER Ø1000)	X	X	○ (XL/XLM)	○	○ (XL/XLM)	○	X		
Jaw	Soft Jaws	○	○	○	○	○	○	○		
	Hardened & ground hard jaws	○	○	○	○	○	○	○		
Chucking option	Single pressure chucking	●	●	●	●	●	●	●		
	Dual pressure chucking	○	○	○	○	○	○	○		
	Chuck clamp confirmation	●	●	●	●	●	●	●		
Steady rest	MANUAL STEADY REST	Ø35 ~ Ø330 mm (Ø1.4 ~ Ø13.0 inch)	○	○	○	○	○	○		
		Ø300 ~ Ø450 mm (Ø11.8 ~ Ø17.7 inch)	○	○	○	○	○	○		
		Ø300 ~ Ø590 mm (Ø11.8 ~ Ø23.2 inch)	(std./M/L/LM)	(LY)	(std./M/L/LM)	(LY)	(std./M/L/LM)	(LY)	(B)	
		Ø380 ~ Ø720 mm (Ø15.0 ~ Ø28.3 inch)	(std./M/L/LM)	(LY)	(std./M/L/LM)	(LY)	(std./M/L/LM)	(LY)	(B)	
		Ø420 ~ Ø570 mm (Ø16.5 ~ Ø22.4 inch)	(XL/XLM)	(XLY)	(XL/XLM)	(XLY)	(XL/XLM)	(XLY)	(LB)	
		Ø570 ~ Ø720 mm (Ø22.4 ~ Ø28.3 inch)	(XL/XLM)	(XLY)	(XL/XLM)	(XLY)	(XL/XLM)	(XLY)	(LB)	
		Hydraulic	SLU-4 (Ø30 ~ Ø245 mm) (Ø1.4 ~ Ø9.6 inch)	○	○	○	○	○	○	○
			SLU-5 (Ø45 ~ Ø310 mm) (Ø1.8 ~ Ø12.2 inch)	○	○	○	○	○	○	○
			SLU-5.1 (Ø85 ~ Ø350 mm) (Ø3.3 ~ Ø13.8 inch)	○	○	○	○	○	○	○
			K-5 (Ø80 ~ Ø390 mm) (Ø3.1 ~ Ø15.4 inch)	○	○	○	○	○	○	○
	SLU-4 (Ø30 ~ Ø245 mm) (Ø1.4 ~ Ø9.6 inch)		○	○	○	○	○	○	○	
	SLU-5 (Ø45 ~ Ø310 mm) (Ø1.8 ~ Ø12.2 inch)		○	○	○	○	○	○	○	
	SLU-5.1 (Ø85 ~ Ø350 mm) (Ø3.3 ~ Ø13.8 inch)		○	○	○	○	○	○	○	
	PROGRAMMABLE STEADY REST	K-5 (Ø80 ~ Ø390 mm) (Ø3.1 ~ Ø15.4 inch)	○	○	○	○	○	○	○	
		K-5.1 (Ø100 ~ Ø410 mm) (Ø3.9 ~ Ø16.1 inch)	○	○	○	○	○	○	○	
		RX-6 (Ø100 ~ Ø520 mm) (Ø3.9 ~ Ø20.5 inch)	○	○	○	○	○	○	○	
		AX-7E (Ø45 ~ Ø320 mm) (Ø1.8 ~ Ø12.6 inch)	○	○	○	○	○	○	○	
		AX-8E (Ø85 ~ Ø360 mm) (Ø3.3 ~ Ø14.2 inch)	○	○	○	○	○	○	○	
		AX-8.5I (Ø100 ~ Ø430 mm) (Ø3.9 ~ Ø16.9 inch)	○	○	○	○	○	○	○	
		AX-9I (Ø100 ~ Ø510 mm) (Ø3.9 ~ Ø20.1 inch)	○	○	○	○	○	○	○	
		Type	Single	○	○	○	○	○	○	○
			Twin	○	○	○	○	○	○	○
			Double	○	○	○	○	○	○	○
	Tailstock	Programmable type	●	●	●	●	●	●	●	
		Live center	●	●	●	●	●	●	●	
		Built-in dead center	○	○	○	○	○	○	○	
	Coolant pump (60/50Hz)	4.5/3.0 bar	●	●	●	●	●	●	●	
7/5, 10/7, 14.5/10, 28/19.5, 70/70 bar		○	○	○	○	○	○	○		
Coolant options	Coolant level switch : Sensing level - Low	○	○	○	○	○	○	○		
	Oil skimmer	○	○	○	○	○	○	○		
	Coolant chiller	○	○	○	○	○	○	○		
	Coolant pressure switch	○	○	○	○	○	○	○		
Chip disposal	Coolant gun	○	○	○	○	○	○	○		
	Chip conveyor (Right side)	○	○	○	○	○	○	○		
	Chip bucket	○	○	○	○	○	○	○		
	Air blower for chuck	○	○	○	○	○	○	○		
	Mist collector interface (Duct only)	○	○	○	○	○	○	○		
Measurement & Automation	Integrated mist collector	○	○	○	○	○	○	○		
	Tool setter	○	○	○	○	○	○	○		
	Manual Automatic	○	○	○	○	○	○	○		
Others	Auto door	○	○	○	○	X	X	X		
	Automatic tool changer	○	○	○	○	X	X	X		
	DN Solutions Tool load monitoring system	●	●	●	●	●	●	●		
	Signal tower	○	○	○	○	○	○	○		
	Air gun	○	○	○	○	○	○	○		
	Automatic power off	○	○	○	○	○	○	○		
	Air unit for air chuck	X	X	X	X	○	X	○		
	Single Twin	X	X	X	X	○	X	○		
	Quick change tooling(CAPTO)	○	○	○	○	○	○	○		
	Auto Tool Changer(ATC)	△	△	△	△	X	X	X		
TOOL ID	○	○	○	○	X	X	X			
Sketch-turn S/W	○	○	○	○	○	○	○			
Standard Accessories	FOUNDATION BOLT FOR ANCHORING	(L/LM/XL/XLM)	●	(L/LM/XL/XLM)	●	(L/LM/XL/XLM)	●	(LB)		
		(LY/XLY)	○	(LY/XLY)	○	(LY/XLY)	○			

Please contact your DN Solutions representative for detailed machine information.

● Standard ○ Optional X N/A



There is a high risk of fire when using non-water-soluble cutting fluids, processing flammable materials, neglecting the controlled and careful use of coolants and modifying the machine without the consent of the manufacturer. Always check the SAFETY GUIDELINES carefully before using the machine.

PERIPHERAL EQUIPMENT

Long boring bar OPTION



The long boring bar option allows customers to easily machine deep holes and reduce cycle time. Please consult with DN Solutions for more details.

Twin chucking OPTION



For more stable pipe threading processing, the twin chucking option (manual or pneumatic) is available. Please consult with DN Solutions for details.

Steady rest OPTION

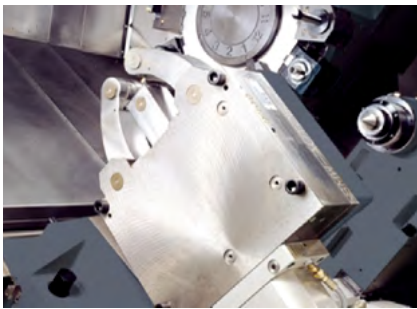

For turning long parts, various types of hydraulic steady rests (Single, Double or Twin type) are available.

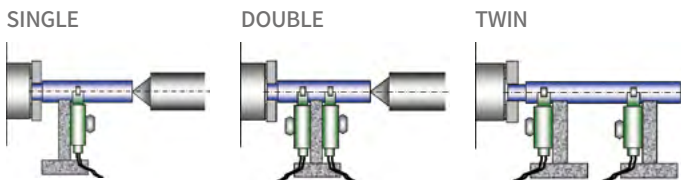

Quick change CAPTO OPTION



The Quick Change Tool system simplifies tool change operations. It is recommended for users who a) need to change tools frequently or b) reduce set-up times.

Coolant tank



Standard bed : 470L
L: 570L (LY: 600L)
XL: 770L

DN Solutions's ergonomic roller coolant tank design, allows users to easily replace and refill coolant. The roller mechanism on the coolant tank allows users to simply take it out and put it back in the machine... similar to a drawer.

Chip conveyor (Right side) OPTION

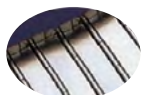

Hinged belt



Magnetic scraper



Chip conveyor type	Material	Description
Hinged belt	Steel	Hinged belt chip conveyor, which is most commonly used for steel work (for cleaning chips longer than 30mm), is available as an option.
Magnetic scraper	Cast Iron	Magnetic scraper type chip conveyor, which is ideal for diecasting work (for cleaning small chips), is available as an option.

Coolant chiller (recommended) OPTION

A coolant chiller is recommended to help prevent temperature rises and to reduce thermal deformation when using a water-insoluble coolant or high-pressure coolant system (i.e., power over 1.5kW).

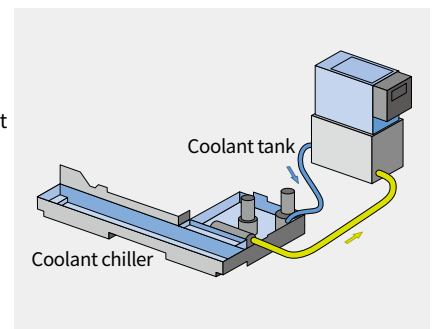

Tool ID system OPTION

Tool ID is available with the Capto ATC option. The small chip that is inserted into the Capto tool memorizes tool data like Tool No., Tool offset, Tool life etc. The customer can access the tool data via RFID (Radio Frequency Identification). Through this function, the customer is able to check the changing time of tool and reduce the potential for human error in calculating the tool offset.

DN SOLUTIONS FANUC i PLUS

DN Solutions Fanuc i Plus maximizes customer productivity and convenience.

15" Screen + New OP

DN Solutions Fanuc i Plus' operation panel enhances operating convenience by incorporating common-design buttons and layout. It features a Qwerty keyboard for fast and easy data input and operation.

DN Solutions Fanuc i Plus

- 15-inch color display
- Intuitive and user-friendly design

USB and PCMCIA card QWERTY keyboard

- EZ-Guide i standard
- Ergonomic operator panel
- 2MB Memory
- Hot keys



iHMI touchscreen OPTION

iHMI provides an intuitive interface that uses a touchscreen for quick and easy operation.

Range of applications

Providing various applications related to planning, machining, improvement and utility, for customer convenience.

SKETCH-TURN OPTION

DN Solutions Conversational programming software for PC

- Easy to learn for beginners
- Time savings in programming
- Reduce processing cycle time



NUMERIC CONTROL SPECIFICATIONS

FANUC

Division	Item	Specifications	2-Axis	M	Y	2-Axis	M	Y
			DN Solutions Fanuc i Plus	DN Solutions Fanuc i Plus	DN Solutions Fanuc i Plus	Fanuc 32i (F32i-B)	Fanuc 32i (F32i-B)	Fanuc 32i (F32i-B)
Controlled axis	Controlled axes		2(X,Z)	3(X,Z,C)	4(X,Z,C,Y)	2(X,Z)	3(X,Z,C)	4(X,Z,C,Y)
	Simultaneously controlled axes		2 axes	3 axes	4 axes	2 axes	3 axes	4 axes
Data input/output	Fast data server		○	○	○	○	○	○
	Memory card input/output		●	●	●	●	●	●
	USB memory input/output		●	●	●	●	●	●
	Larger capacity memory_2GB	Note *2) Available Option only with 15" Touch LCD (iHMI Only)	○ *2)	○ *2)	○ *2)	X	X	X
Interface function	Embedded Ethernet		●	●	●	●	●	●
	Fast Ethernet		○	○	○	○	○	○
	Enhanced Embedded Ethernet function		●	●	●	●	●	●
Operation	DNC operation	Included in RS232C interface.	●	●	●	●	●	●
	DNC operation with memory card		●	●	●	●	●	●
Program input	Workpiece coordinate system	G52 - G59	●	●	●	●	●	●
Feed function	AI contour control I	G5.1 Q_ , 40 Blocks	○	○	●	○	○	●
	AI contour control II	G5.1 Q_ , 200 Blocks	○	○	○	○	○	○
	EZ Guidei (Conversational Programming Solution)		●	●	●	●	●	●
Operation Guidance Function	iHMI with Machining Cycle	Note *1) Only with 15" Touch LCD standard	○ *1)	○ *1)	○ *1)	X	X	X
	EZ Operation package		●	●	●	●	●	●
Setting and display	CNC screen dual display function		●	●	●	●	●	●
Network	FANUC MTConnect		✳	✳	✳	✳	✳	✳
	FANUC OPC UA		✳	✳	✳	✳	✳	✳
Others	Display unit	15" color LCD	●	●	●	●	●	●
		15" color LCD with Touch Panel	○	○	○	X	X	X
	Part program storage size & Number of registerable programs	640M(256KB)_500 programs	X	X	X	●	●	●
		5120M(2MB)_1000 programs	●	●	●	○	○	○

Network: FANUC MTConnect and FANUC OPC UA available.

● Standard ○ Optional X N/A ✳ Available

CONVENIENT OPERATION

SIEMENS S828D

15.inch display + New OP

Siemens 828D' operation panel enhances operating convenience by incorporating common-design buttons and layout. It features a Qwerty keyboard for fast and easy data input and operation.

- 15.6 inch display
- USB (standard)
- QWERTY keyboard



Convenient conversational functionality

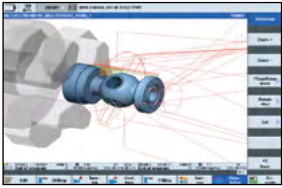

Cutting and operation support function

This function shows a cutting and tool path simulation in real-time.

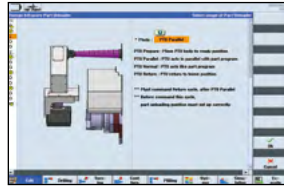

Shop-turn mode
[various]
↓
[attachments]

The automation elements (parts catcher, parts unloader etc.), can be easily controlled via interactive screens.

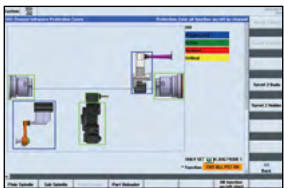

[Custom]
↓
[Protection zones]

Operation safety function

Protection Zone Synchronized Actions checks the interference between the turret and the spindle to prevent collisions caused by operator error.



[offset]
↓
[operating parameter]
↓
[TC service]

Maintenance and service convenience function

Maintenance and service of major equipment and peripheral devices, including the timer and parts counter settings can be easily undertaken.

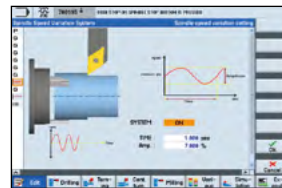

[various]
↓
[attachment]
↓
[DSSV]

Machining accuracy improvement

The NC controls spindle speed at an optimal level for precision threading and turning, making it possible to automatically improve surface roughness.



NUMERIC CONTROL SPECIFICATIONS

SIEMENS

Division	Item	Specifications	2-Axis	M	S	MS	Y	SY
			S828D	S828D	S828D	S828D	S828D	S828D
Controlled axis	Controlled axes		X,Z,SP	X,Z,C,R	X,Z,C,C2,B	X,Z,C,R,C2,B	X,Z,C,R,Y	X,Z,C,R,C2,Y,B
	Simultaneously controlled axes		4 axes	4 axes	4 axes	4 axes	4 axes	4 axes
Data input/output	Memory card input/output		X	X	X	X	X	X
	USB memory input/output		●	●	●	●	●	●
Interface function	Ethernet (X130)		○	○	○	○	○	○
	On network drive (without EES option, Extcall)		○	○	○	○	○	○
Operation	On USB storage medium, e.g. memory stick	(without EES option, Extcall)	●	●	●	●	●	●
	Workpiece coordinate system	G54 - G59, G507 - G599	●	●	●	●	●	●
Feed function	Advanced surface		X	X	X	X	X	X
	Top surface		X	X	X	X	X	X
	Look ahead number of block		1	1	1	1	1	1
Programming & Editing function	3D simulation, finished part		●	●	●	●	●	●
	Simultaneous recording		●	●	●	●	●	●
	DXF Reader for PC integrated in SINUMERIK Operate		○	○	○	○	○	○
Operation Guidance Function	Shopturn		●	●	●	●	●	●
	EZ Operation package		●	●	●	●	●	●
Setting and display	Operation via a VNC viewer		●	●	●	●	●	●
	Network		●	●	●	●	●	●
Others	Display unit	15.6" color display with touch screen	●	●	●	●	●	●
		CNC user memory 10 MB	●	●	●	●	●	●
	Part program storage size	CNC user memory 100 MB	○	○	○	○	○	○
		CNC user memory 6GB	X	X	X	X	X	X
		CNC user memory 40GB (with PCU or IPC)	X	X	X	X	X	X
		CNC user memory without limit(Execution from external storage devices)(EES / Using by USB or Network)	○	○	○	○	○	○
		HMI user memory for CNC part program 6GB	X	X	X	X	X	X

● Standard ○ Optional X N/A ⊕ Available

STABLE THREADING PERFORMANCE

All PUMA 600/ 700/ 800 II series (2-Axis* to Y-Axis) are capable of threading work.

* In order to re-machine threads or perform arbitrary speed threading on a 2-Axis machine, additional optional devices have to be selected.

Threading repair function

This function allows users to repair threads even when the original program is not available. This is a standard Fanuc NC function.

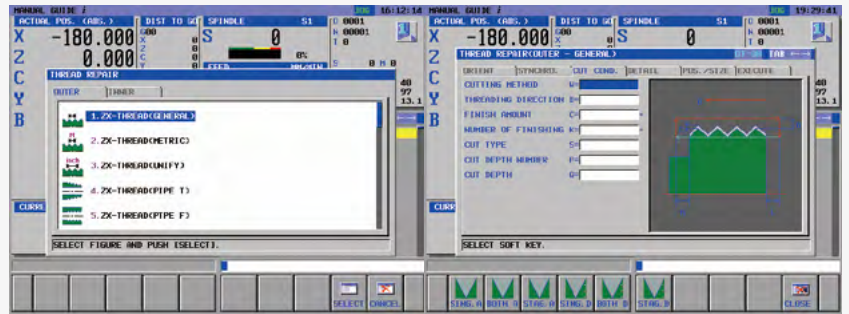

Arbitrary speed threading

OPTION

This function allows users to control and override spindle speeds in order to set them to produce/replicate the best thread quality.

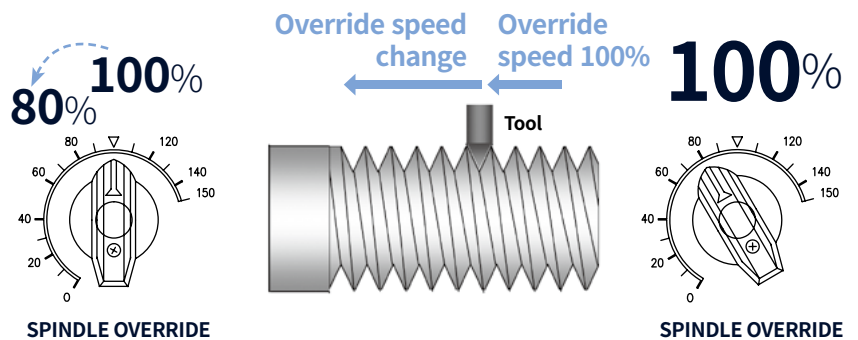

Re-machining function

OPTION

This function is included in the arbitrary speed threading. It allows users to re-machine damaged threads using the existing program.

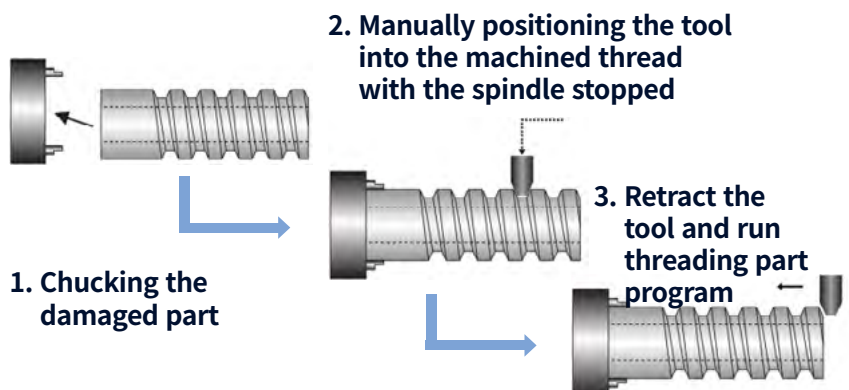

POWER & TORQUE

FANUC

PUMA 600 II series

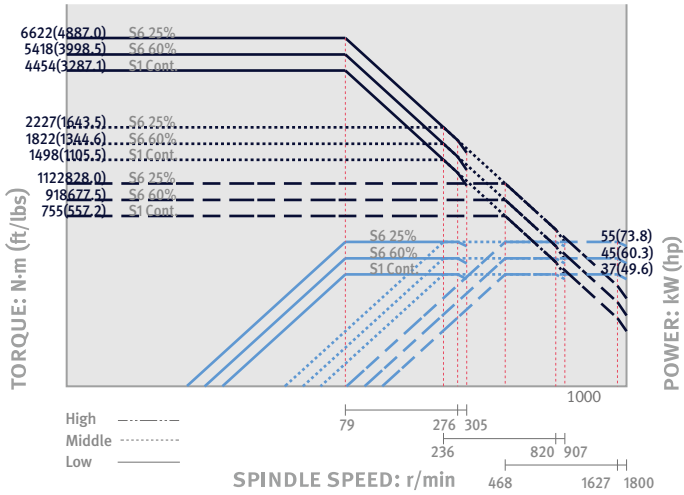

PUMA 700 II series

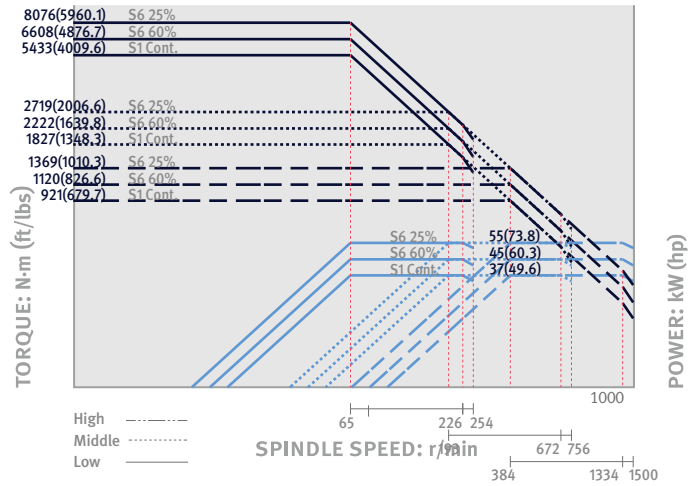

PUMA 800 II series

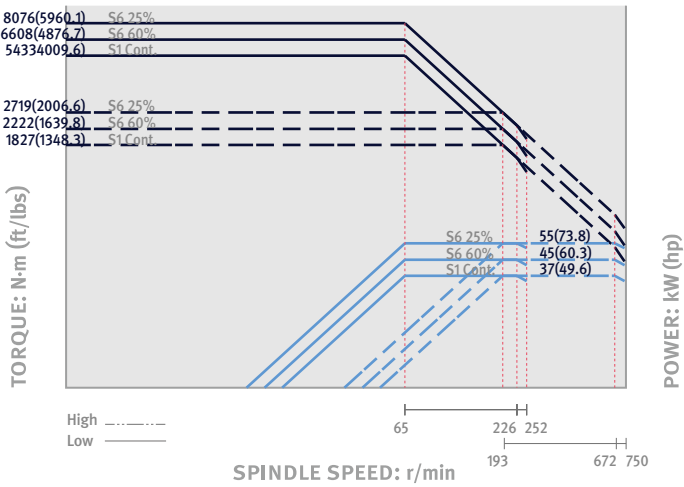

PUMA 800B/LB II series

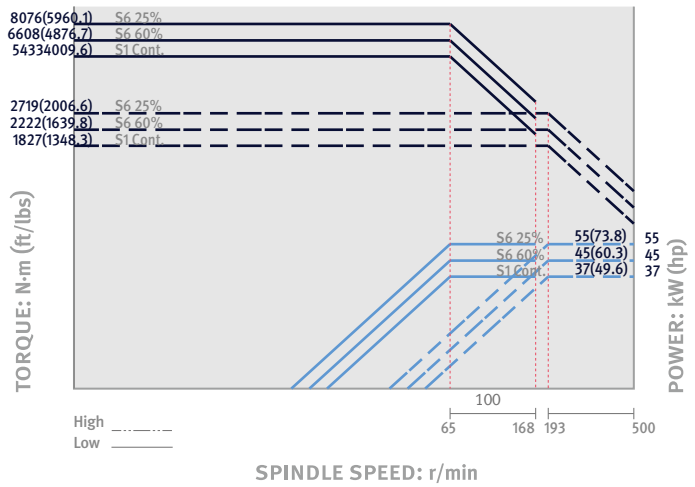

Rotary tool

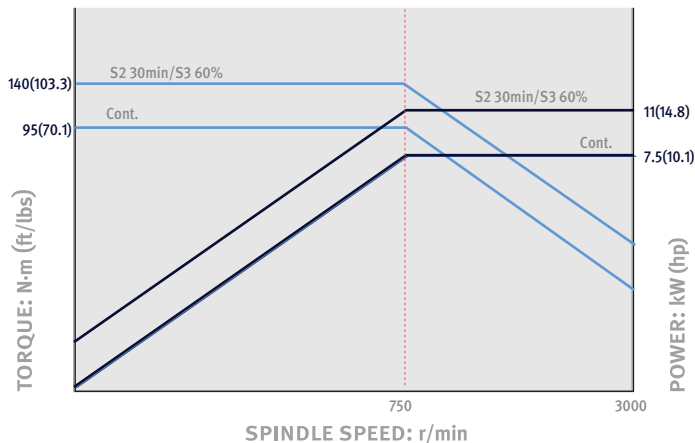

POWER & TORQUE

SIEMENS

PUMA 600 II series

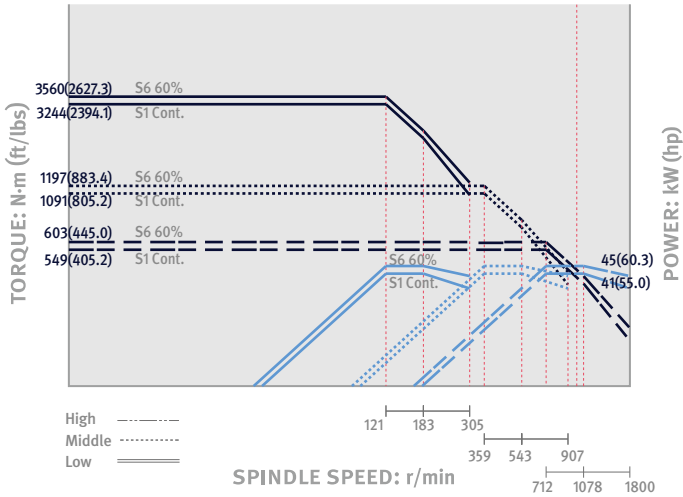

PUMA 700 II series

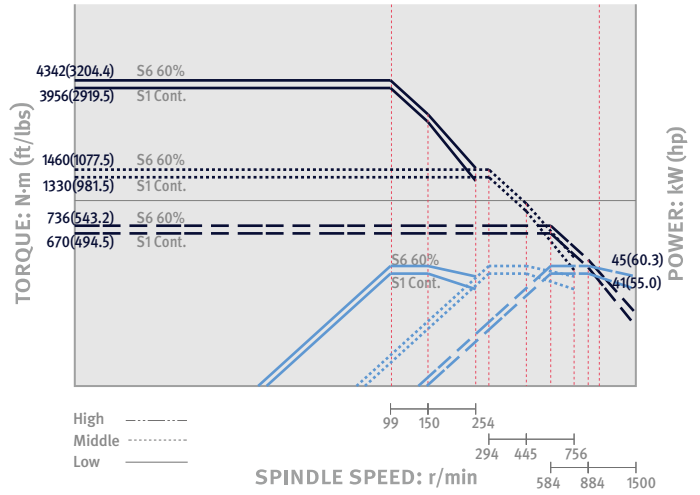

PUMA 800 II series

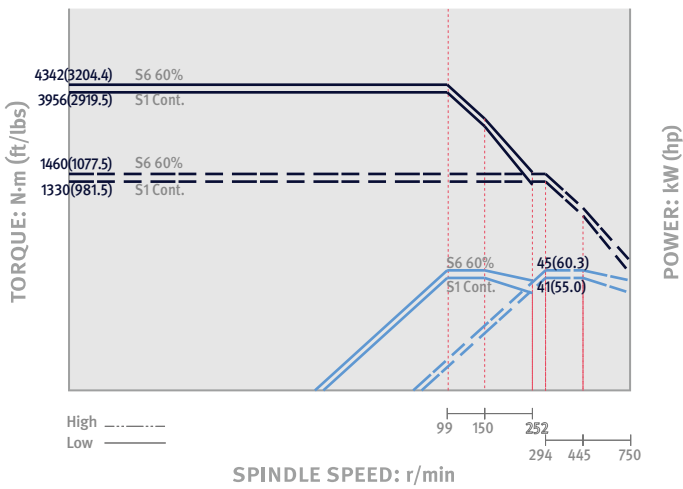

PUMA 800B/LB II series

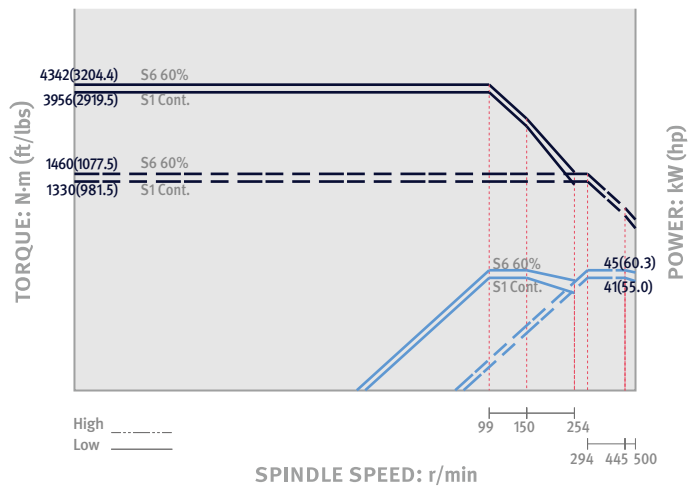

Rotary tool _ M/LM/XLM

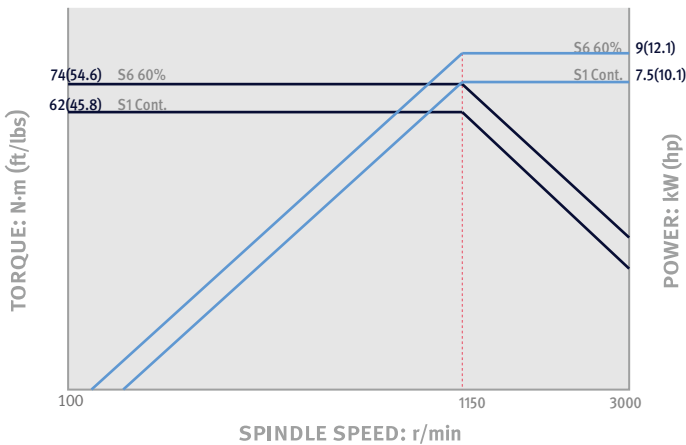

Rotary tool _ LY/XLY

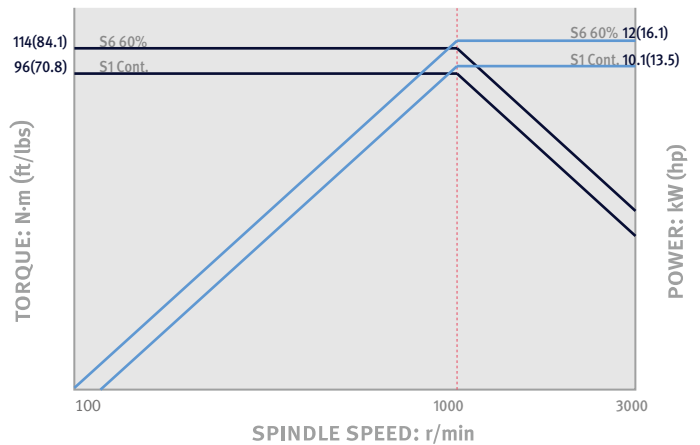

POWER & TORQUE

FANUC OPTION

PUMA 600 II series

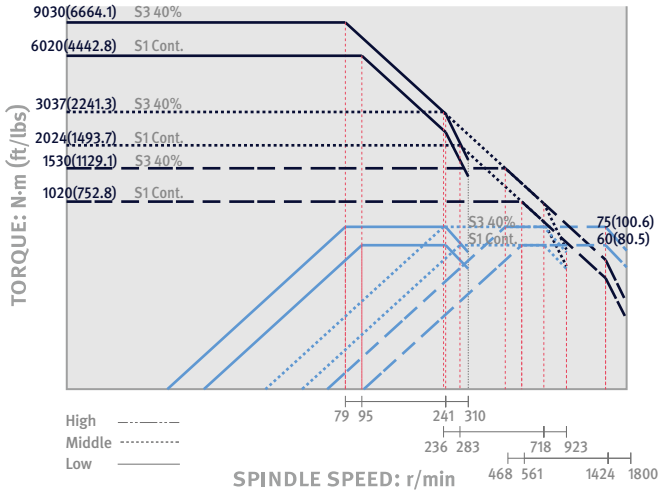

PUMA 700 II series

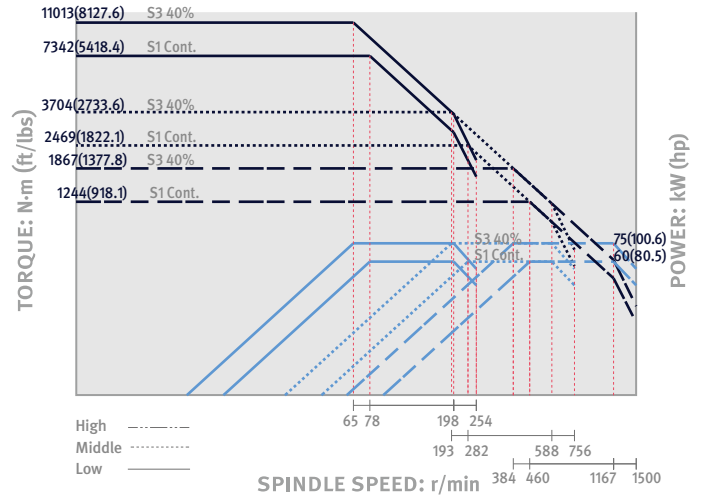

PUMA 800 II series

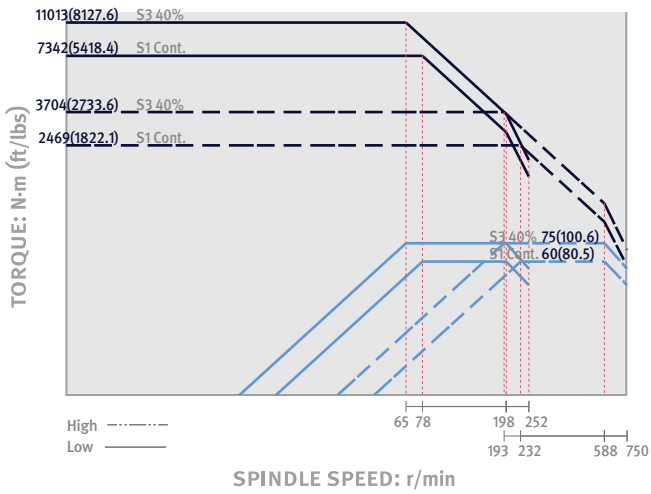

PUMA 800B/LB II series

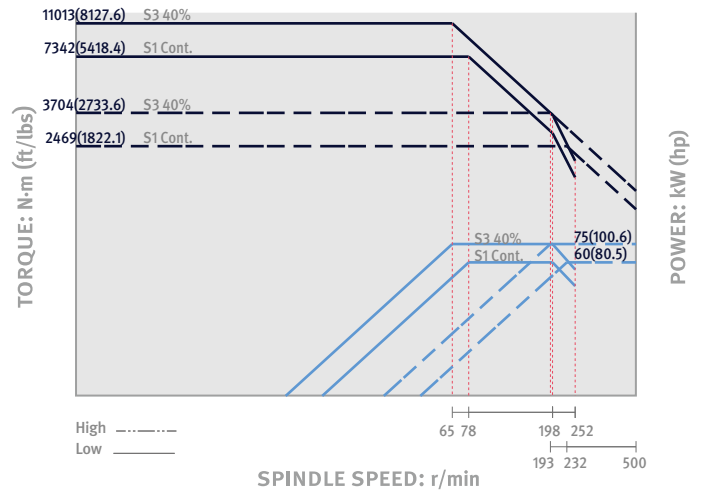

POWER & TORQUE

SIEMENS OPTION

PUMA 600 II series

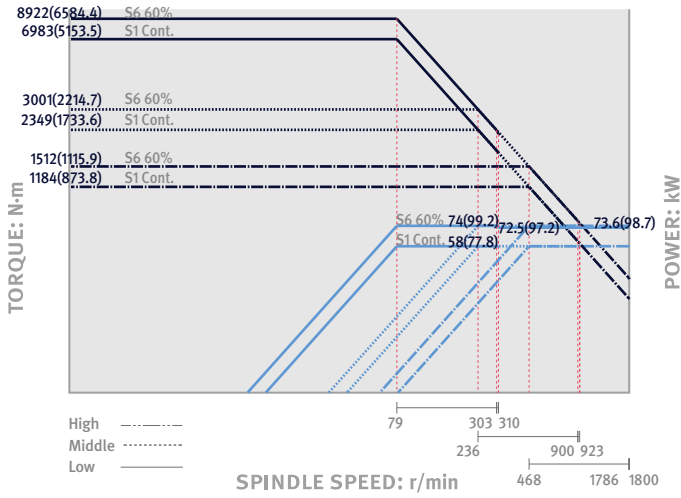

PUMA 700 II series

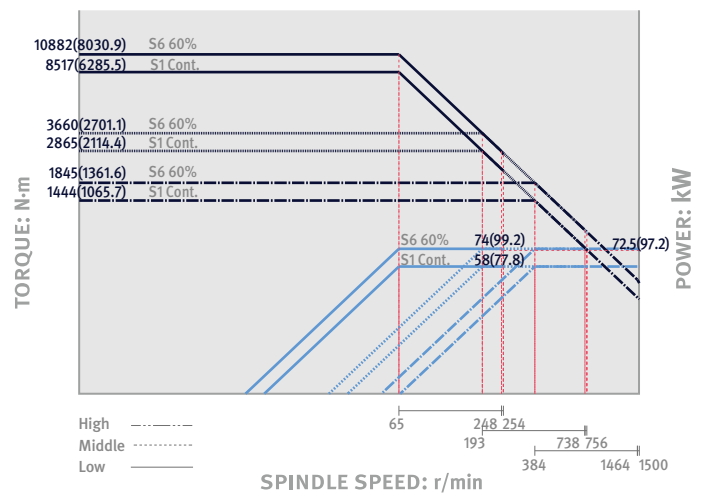

PUMA 800 II series

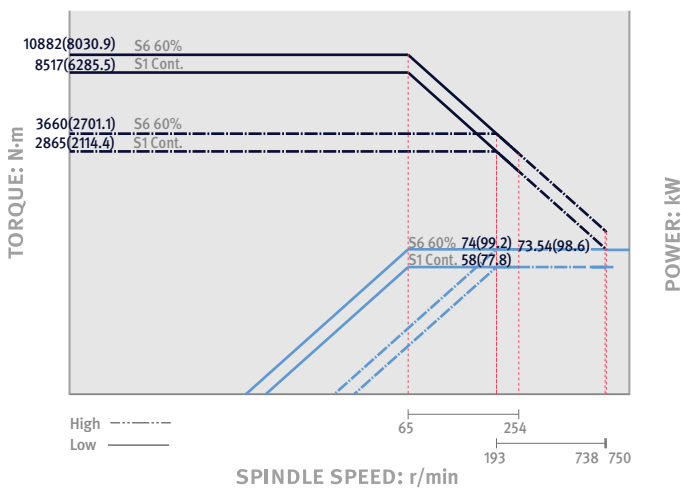

PUMA 800B/LB II series

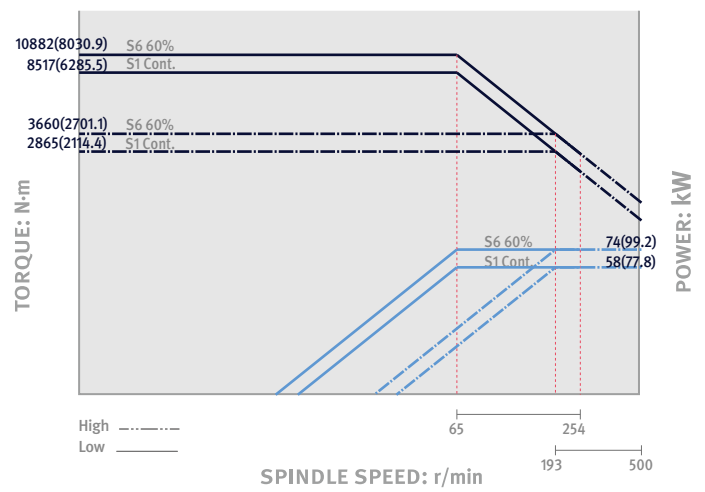

EXTERNAL DIMENSIONS

PUMA 600/700/800 II series

Unit : mm (inch)

TOP

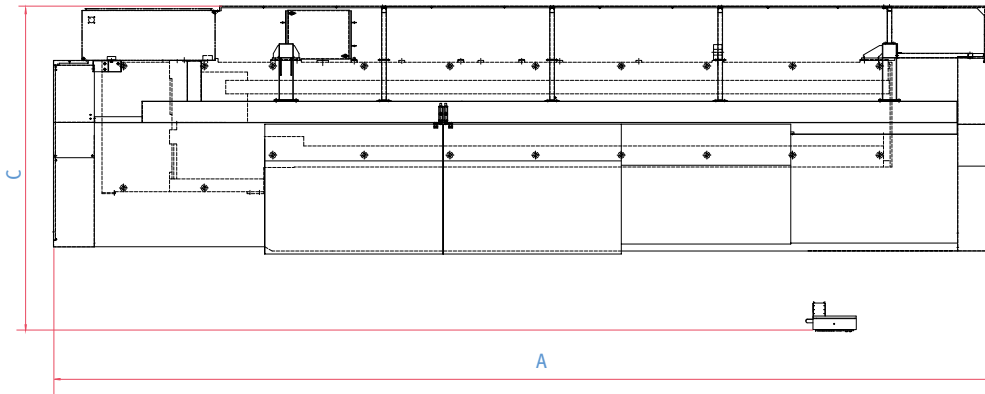

FRONT

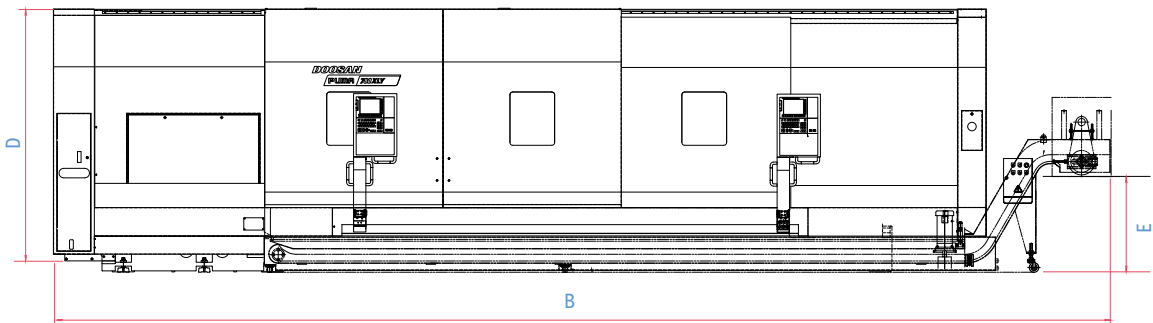

Model	A (Length)	B* (Length with chip conveyor)	C (Width)	D (Height)	E (지면부터 칩 배출구까지 높이)
PUMA 600/700/800 II [M]	5756 (226.6)	6911 (272.1)	3160 (124.4)	2800 (110.2)	1020 (40.2)
PUMA 600L/700L/800L II [M]	7354 (289.5)	8510 (355.0)	2713.5 (106.8)	2590 (102.0)	1020 (40.2)
PUMA 600LY/700LY/800LY II	7443 (293.0)	8592 (338.3)	3031 (119.3)	2855 (112.4)	1005 (39.6)
PUMA 600XL/700XL/800XL II [M]	9904 (389.9)	11010 (433.5)	2955 (116.3)	2855 (112.4)	1020 (40.2)
PUMA 600XLY/700XLY/800XLY II	9904 (389.9)	11112 (437.5)	2955 (116.3)	2855 (112.4)	1005 (39.6)
PUMA 800B II	5756 (226.6)	6911 (272.1)	3160 (124.4)	2800 (110.2)	1020 (40.2)
PUMA 800LB II	7354 (289.5)	8510 (355.0)	2713.5 (106.8)	2590 (102.0)	1020 (40.2)

* 500mm of a space is required to the right of the machine in order to install and remove chip conveyor.

* Machine foundation : Anchoring is recommended to maintain accuracy over a long period of time, The anchor bolts and other related parts of foundation work are supplied as standard items. Please consult with DN Solutions and sales technicians regarding ground and operating conditions.

* Some peripheral equipment can be placed in other places.

TOOLING SYSTEM

Unit : mm (inch)

PUMA 600/700/800II [L/XL], PUMA 800B/LBII

표준공급품

* ()공급수량

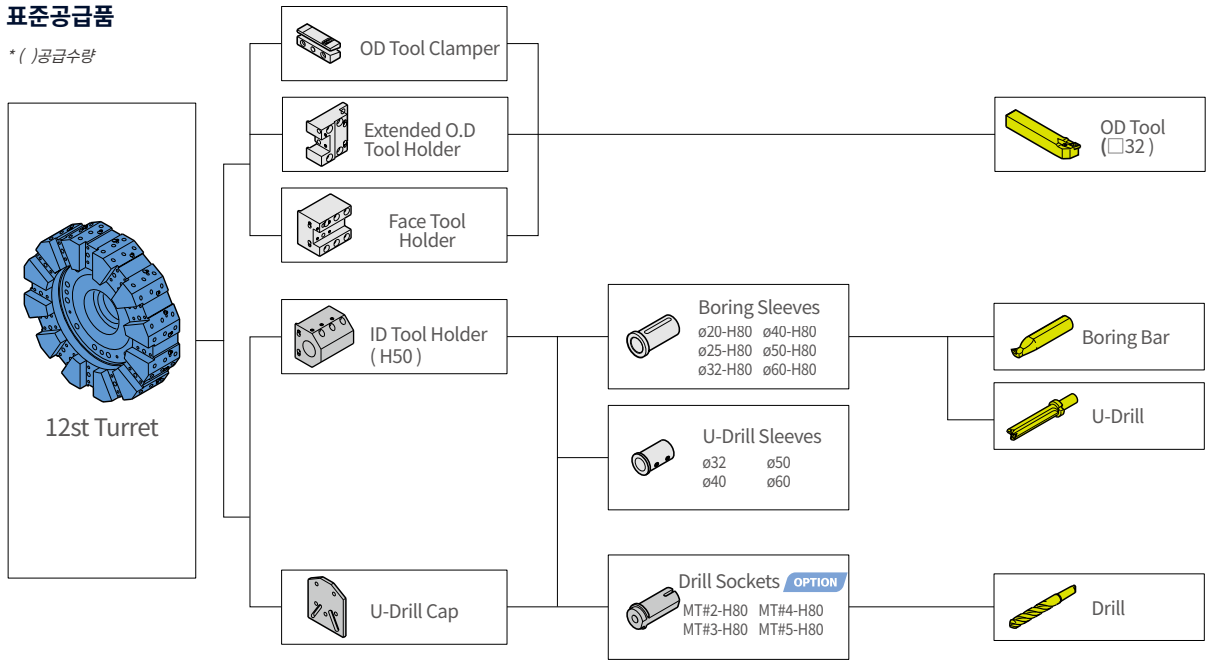

PUMA 600M/700M/800MII [LM/LY/XLM/XLY]

표준공급품

* ()공급수량

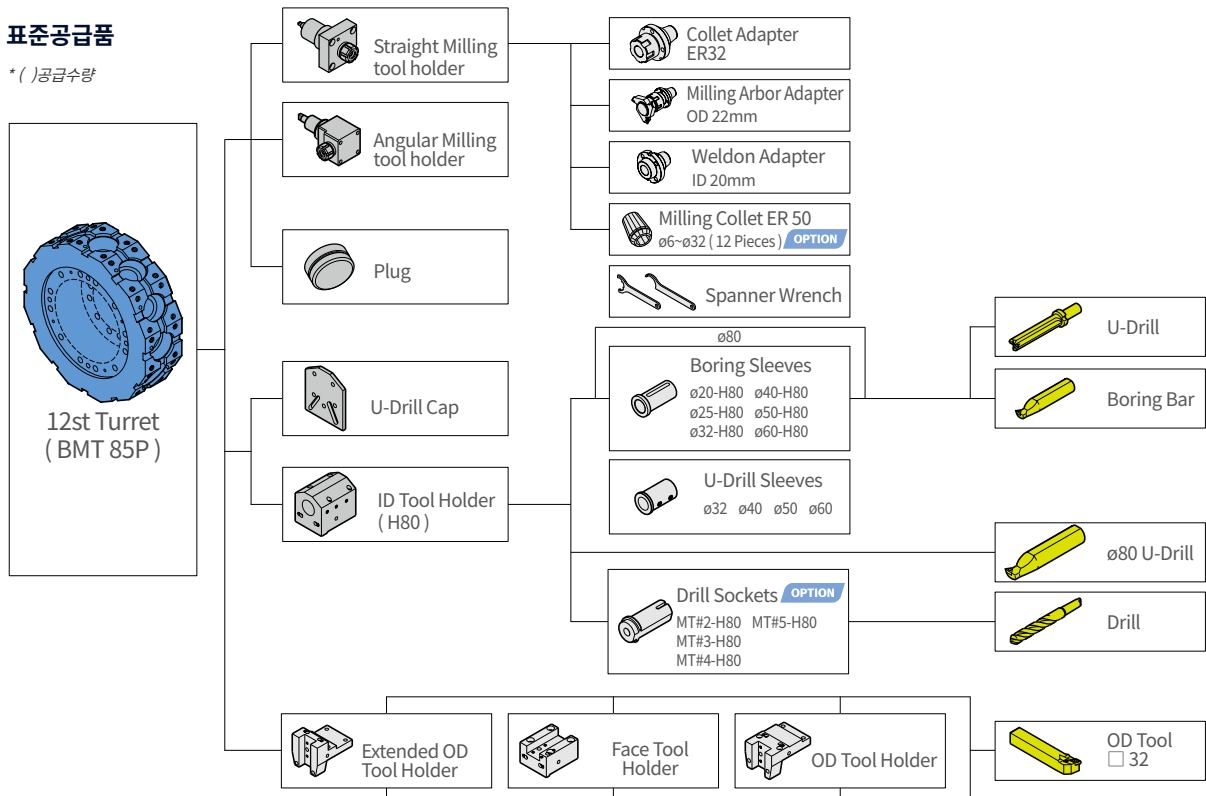

TOOL INTERFACE

Unit : mm (inch)

PUMA 600/700/800II [L/XL], PUMA 800B/LBII

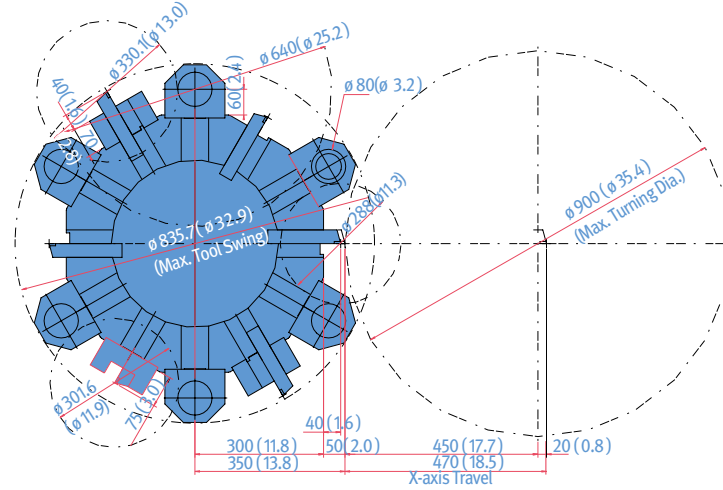

PUMA 600M/700M/800MII [LM/XLM]

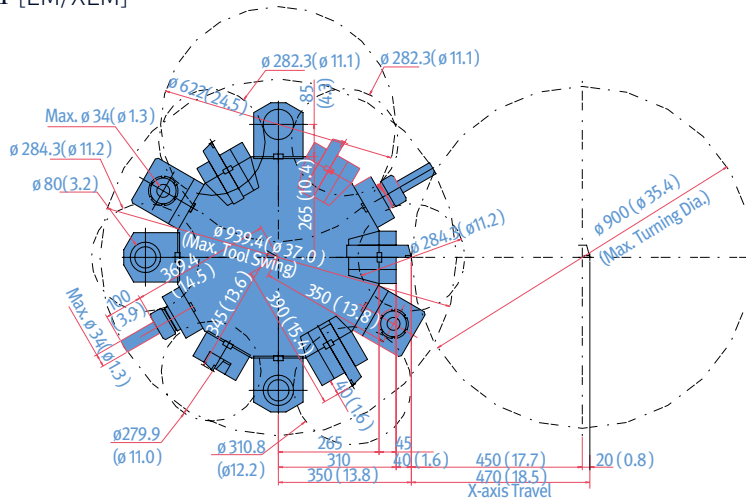

PUMA 600M/700M/800MII [XLY]

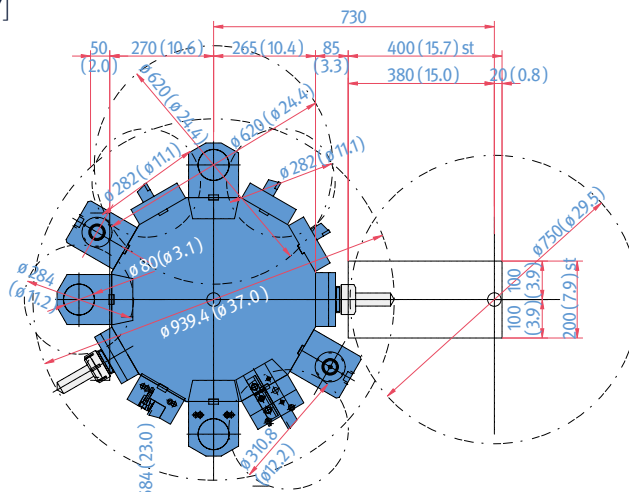

WORKING RANGE

PUMA 600/700/800 II [L/XL], PUMA 800B II [LB]

Unit : mm (inch)

OD TOOL HOLDER

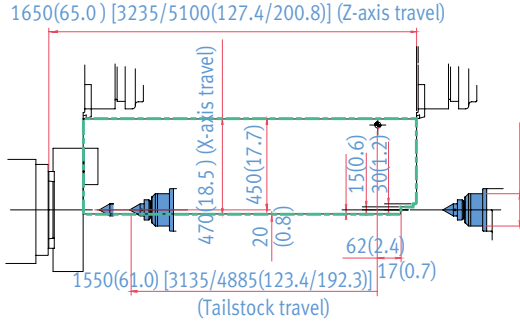

ID TOOL HOLDER

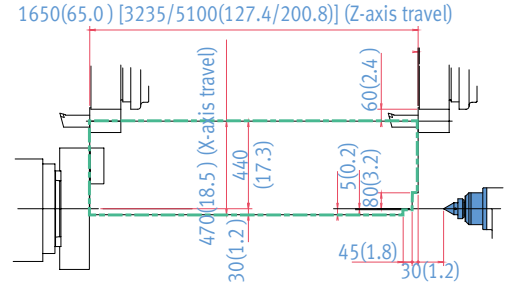

PUMA 600/700/800 II [LM/XLM]

OD TOOL HOLDER

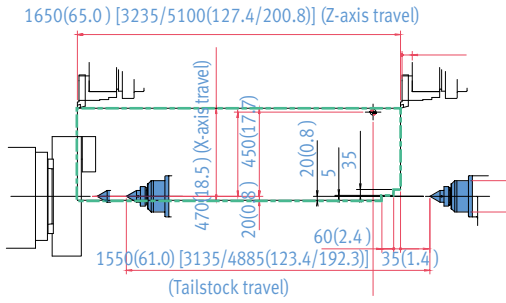

ID TOOL HOLDER

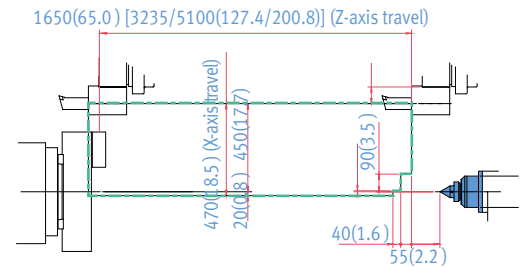

STRAIGHT MILLING TOOL HOLDER

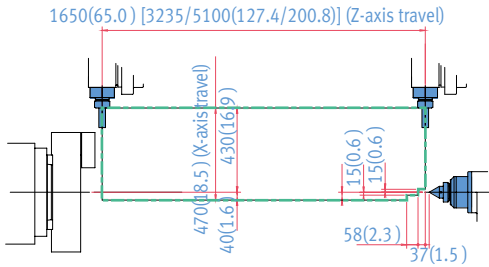

ANGULAR MILLING TOOL HOLDER

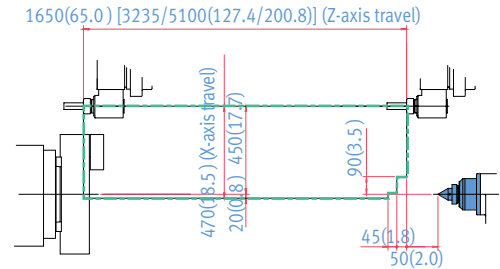

PUMA 600/700/800 II [XLY]

OD TOOL HOLDER

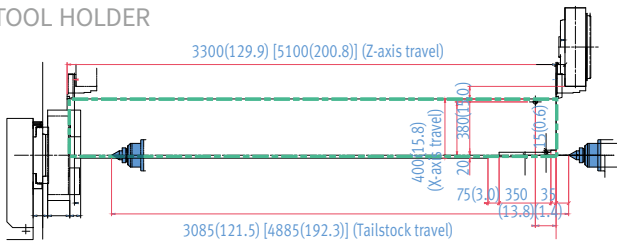

ID TOOL HOLDER

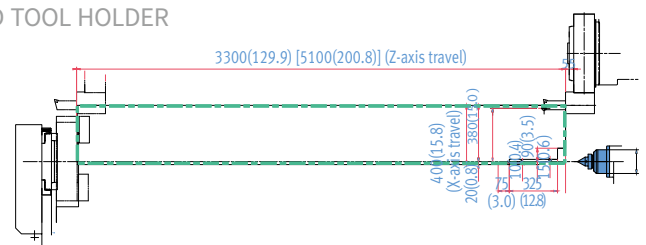

STRAIGHT MILLING TOOL HOLDER

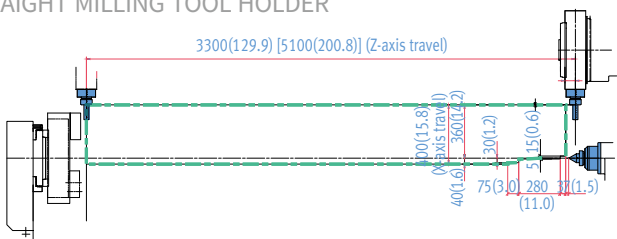

ANGULAR MILLING TOOL HOLDER

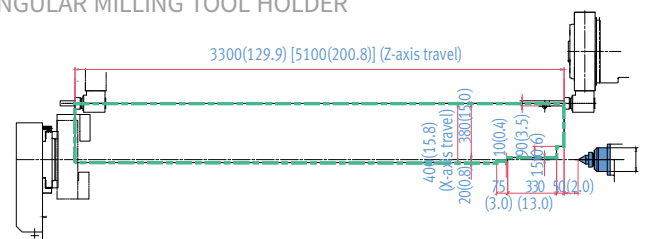

MACHINE SPECIFICATIONS

PUMA 600/700/800 IIseries

Description		Unit	PUMA 600 II [L/XL]	PUMA 600M II [LM/XLM]	PUMA 600LY II [XLY]	
Capacity	Swing over bed	mm(inch)	1030(40.6) [1000(39.4)/1140(44.9)]		1140(44.9)	
	Swing over saddle	mm(inch)	800(31.5) [800(31.5)/1000(39.4)]		1000(39.4)	
	Recom. turning diameter	mm(inch)	600(23.6)		700(27.6)	
	Max. turning diameter	mm(inch)	900(35.4)		750(29.5)	
	Max. turning length	mm(inch)	1600(63) [3200(126)/5050(199)]		3250(128) [5050(199)]	
	Chuck size	inch	18			
	Bar working diameter	mm(inch)	117(4.6)			
Travels	Travel distance	X-axis	mm(inch)	470(18.5)	400(15.7)	
		Y-axis	mm(inch)	-	200 (7.9)	
		Z-axis	mm(inch)	1650(65) [3235(127)/5100(201)]		3300(130) [5100(201)]
Feedrates	Rapid traverse rate	X-axis	m/min(ipm)	12(472.4)		
		Y-axis	m/min(ipm)	-	6(236.2)	
		Z-axis	m/min(ipm)	16(630.0) [10(393.7)/10(393.7)]		10(393.7)
Main Spindle	Max. spindle speed		r/min	1800		
	Main spindle motor power	FANUC (S6 25%/ S6 60% / S1 Cont.)	kW(Hp)	55/45/37(73.8/60.3/49.6) {75/60(100.1/80.5) (S3 60% / S1 Cont.)}*		
		SIEMENS (S6 60% / S1 Cont.)		45/41 {74/58}* (60.3/55.0 {99.2/77.8}) (S6 60% / S1 Cont.)		
	Max. spindle torque	FANUC	N·m(lbf·ft)	6622 {9030}* (4887.0{6664.1})		
		SIEMENS		3560 {8922}* (2627.3 {6584.4})		
	Spindle nose		ASA	A2-15		
	Spindle bearing diameter (Front)		mm(inch)	200(7.9)		
	Spindle through hole diameter		mm(inch)	152(6.0)		
Min. spindle indexing angle (C-axis)		deg	-	0.001		
Turret	No. of tool stations		ea	12		
	OD tool size		mm(inch)	32 x 32 (1.3 x 1.3)		
	Max. boring bar size		mm(inch)	80 (3.1)		
	Turret indexing time (1 station swivel)		s	0.25		
	Max. rotary tool speed		r/min	-	3000	
	Rotary tool motor power	FANUC (30min)	kW(hp)	-	11(14.8)	
		SIEMENS (S6 60%)	-	-	9(12.1)	12(16.1)
Tailstock	Tailstock travel		mm(inch)	1550(61) [3135(123)/4885(192)]		
	Quill diameter		mm(inch)	160(6.3) [160(6.3)/180(7.1)]		
	Quill travel		mm(inch)	150(5.9)		
	Quill bore taper		MT	#6 {#6(Dead)}*		
Power Source	Electric power supply (rated capacity)		kVA	64.44	68.60	
Machine Dimensions	Length		mm(inch)	5756 (226.6) [7354(289.5) /9904(389.9)]		
	Width		mm(inch)	3160 (124.4) [2713(106.8) /2955(116.3)]		
	Height		mm(inch)	2800 (110.2) [2590 (102.0) /2855 (112.4)]		
	Weight		kg(lb)	16500 (36375.7) [22000 (48501.0)/26000 (57319.3)]		
Control	NC system		-	DN Solutions Fanuc i Plus / SIEMENS S828D		

MACHINE SPECIFICATIONS

PUMA 600/700/800 II series

Description		Unit	PUMA 700 II [L/XL]	PUMA 700M II [LM/XLM]	PUMA 700LY II [XLY]	PUMA 800 II [L/XL]	PUMA 800M II [LM/XLM]	PUMA 800LY II [XLY]	PUMA 800B II [LB]
Capacity	Swing over bed	mm (inch)	1030(40.6) [1000(39.4)/1140(44.9)]		1140(44.9)	1030(40.6) [1000(39.4)/1140(44.9)]		1140(44.9)	1030(40.6) [1000(39.4)]
	Swing over saddle	mm (inch)	800(31.5) [800(31.5)/1000(39.4)]		1000(39.4)	800(31.5) [800(31.5)/1000(39.4)]		1000(39.4)	800(31.5)
	Recom. turning diameter	mm (inch)	700(27.6)			800(31.5)		700(27.6)	800(31.5)
	Max. turning diameter	mm (inch)	900(35.4)		750(29.5)	900(35.4)		750(29.5)	900(35.4)
	Max. turning length	mm (inch)	1600(63) [3200(126)/5050(199)]		3250(128) [5050(199)]	1600(63) [3200(126)/5050(199)]		3250(128) [5050(199)]	1600(63) [3200(126)]
	Chuck size	inch	24			32			Order made
	Bar working diameter	mm (inch)	164(6.5)			Depending on chuck spec.			
Travels	Travel distance	X-axis	470(18.5)		400(15.7)	470(18.5)		400(15.7)	470(18.5)
		Y-axis	-		200 (7.9)	-		200 (7.9)	-
		Z-axis	1650(65) [3235(127)/5100(201)]		3300(130) [5100(201)]	1650(65) [3235(127)/5100(201)]		3300(130) [5100(201)]	1650(65) [3235(127)]
Feedrates	Rapid traverse rate	X-axis	12(472.4)			12(472.4)			
		Y-axis	-		6(236.2)	-		6(236.2)	-
		Z-axis	16(630.0) [10(393.7)/10(393.7)]		10(393.7)	16(630.0) [10(393.7)/10(393.7)]		10(393.7)	16(630.0) [10(393.7)]
Main Spindle	Max. spindle speed	r/min	1500			750			500
	Main spindle motor power	FANUC (S6 25%/ S6 60% / S1 Cont.)	55/45/37(73.8/60.3/49.6) {75/60(100.1/80.5) (S3 60% / S1 Cont.)}*			55/45/37(73.8/60.3/49.6) 75/60(100.1/80.5) (S3 60% / S1 Cont.)*			
		SIEMENS (S6 60% / S1 Cont.)	45/41 {74/58}* (60.3/55.0 {99.2/77.8})			45/41{74/58}* (60.3/55.0 {99.2/77.8}) (S6 60% / S1 Cont.)			
	Max. spindle torque	FANUC	8076(5960.1) [11013(8127.6)]*			8076(5960.1) [11013(8127.6)]*			
		SIEMENS	4342 {10882}* (3204.4 {8030.9})			4342 {10882}* (3204.4 {8030.9})			
	Spindle nose	ASA	A1-15			A1-20			ISO 702-4 NO.20
	Spindle bearing diameter (Front)	mm (inch)	240(9.4)			400(15.7)			440(17.3)
Spindle through hole diameter	mm (inch)	181(7.1)			320(12.6)			375(14.8)	
Min. spindle indexing angle (C-axis)	deg	-	0.001		-	0.001 {1}	0.001	-	
Turret	No. of tool stations	ea	12			12			
	OD tool size	mm (inch)	32 x 32 (1.3 x 1.3)			32 x 32 (1.3 x 1.3)			
	Max. boring bar size	mm (inch)	80 (3.1)			80 (3.1)			
	Turret indexing time (1 station swivel)	s	0.25			0.25			
	Max. rotary tool speed	r/min	-	3000		-	3000		-
	Rotary tool motor power	FANUC (30min)	11(14.8)			11(14.8)			
SIEMENS (S6 60%)		-	9(12.1)	12(16.1)	-	9(12.1)	12(16.1)	-	
Tailstock	Tailstock travel	mm (inch)	1550(61) [3135(123)/4885(192)]		3085(121) [4885(192)]	1550(61) [3135(123)/4885(192)]		3085(121) [4885(192)]	1550(61) [3135(123)]
	Quill diameter	mm (inch)	160(6.3) [160(6.3)/180(7.1)]		180(7.1)	160(6.3) [160(6.3)/180(7.1)]		180(7.1)	160(6.3)
	Quill travel	mm (inch)	150(5.9)		150(5.9)	150(5.9)			150(5.9)
	Quill bore taper	MT	#6 {#6(Dead)}*			#6 {#6(Dead)}*			
Power Source	Electric power supply (rated capacity)	kVA	64.44	68.60	69.90	64.44	68.60	69.90	64.44
Machine Dimensions	Length	mm (inch)	5756 (226.6) [7354/9904 (289.5/389.9)]		7443(293.0) [9904(389.9)]	5756 (226.6) [7354/9904 (289.5/389.9)]		7443(293.0) [9904(389.9)]	5756 (226.6) [7354 (289.5)]
	Width	mm (inch)	3160 (124.4) [2713(106.8)/2955(116.3)]		3031 (119.3) [2955 (116.3)]	3160 (124.4) [2713(106.8)/2955(116.3)]		3031 (119.3) [2955 (116.3)]	3160 (124.4) [2713(106.8)]
	Height	mm (inch)	2800 (110.2) [2590 (102.0)/2855 (112.4)]		2855 (112.4)	2800 (110.2) [2590 (102.0)/2855 (112.4)]		2855 (112.4)	2800 (110.2) [2590 (102.0)]
	Weight	kg(lb)	16500 (36375.7) [22000(48501.0)/26000 (57319.3)]		23000(50706) [26000(57320)]	16500(36375.7)[22000(48501.0)/26000 (57319.3)]		23000 (50705.6) [26000 (57319.3)]	16500 (36375.7) [22000 (48501.0)]
Control	NC system	-	DN Solutions Fanuc i Plus / SIEMENS S828D						

* { } : option

RESPONDING TO CUSTOMERS ANYTIME, ANYWHERE

DN Solutions Global Network

DN Solutions provides systems-based professional support services, before and after the machine tool sale, by responding quickly and efficiently to customers. By supplying spare parts, product training, field service and technical support, we provide the expert care, attention and assistance our customers expect from a market leader.

Global sales and service support network		51	Technical centers Technical center, Sales support, Service support, Parts support
4	Corporations	200	Service posts
156	Dealer networks	3	Factories



CUSTOMER SUPPORT AND SERVICES

We're there for you whenever you need us.

We help our customers operate at maximum efficiency by providing them with a range of tried, tested and trusted services - from pre-sales consultancy to post-sales support.



Field services

- On-site service
- Machine installation and testing
- Scheduled preventive maintenance
- Machine repair service



Parts supply

- Supplying a wide range of original DN Solutions spare parts
- Parts repair service



Training

- Programming, machine setup and operation
- Electrical and mechanical maintenance
- Applications engineering



Technical support

- Supports machining methods and technology
- Responds to technical queries
- Provides technical consultancy



dn-solutions.com

Head Office

22F T Tower, 30, Sowol-ro 2-gil
Jung-gu, Seoul, Korea, 04637

Tel: +82-2-6972-0370/0350
Fax: +82-2-6972-0400

DN Solutions America

19A Chapin Road, Pine Brook
New Jersey 07058, United States

Tel: +1-973-618-2500
Fax: +1-973-618-2501

DN Solutions Europe

Emdener Strasse 24, D-41540
Dormagen, Germany

Tel: +49-2133-5067-100
Fax: +49-2133-5067-111

DN Solutions India

No.82, Jakkuar Village
Yelahanka Hobli, Bangalore-560064

Tel: + 91-80-2205-6900
E-mail: india@dncompany.com

DN Solutions China

Room 101,201,301, Building 39 Xinzhuan
Highway No.258 Songjiang District
China Shanghai (201612)

Tel: +86 21-5445-1155
Fax: +86 21-6405-1472

Sales inquiry

sales@dncompany.com

* For more details, please contact DN Solutions.

* Specifications and information contained within this catalogue may be changed without prior notice.