

DOOSAN



Mynx II series

Heavy Duty Vertical Machining Center

Mynx II series

Mynx 5400 II
Mynx 6500 II
Mynx 7500 II
Mynx 9500



**MACHINE
GREATNESS™**

Basic information

Basic Structure
Cutting
Performance

Detailed Information

Options
Applications
Diagrams
Specifications

Customer Support Service



Mynx 5400 II

Mynx II series

Mynx II series offers a wide line-up from 550 mm (21.7 inch) to 950 mm (37.4 inch) and various spindle enabling to meet the user to handle a wider range of workpieces. In addition, Mynx series offers high durability, high performance to designed high rigidity. The EOP functions for the user-friendliness has improved the convenience of customers.

Contents

02 Product Overview

Basic Information

- 04 Basic Structure
- 07 Cutting Performance

Detailed Information

- 08 Standard / Optional Specifications
 - 10 Applications
 - 13 Capacity Diagram
 - 19 Machine / CNC Specifications
- ### 26 Customer Support Service



Users can be selected according to material and size of workpiece

- Wide line-up from 550mm (21.7 inch) to 950mm (37.4 inch) and various spindle are available to meet material and size of workpiece.

High productivity and stable precision, powerful cutting performance

- High-rigidity machine structure provides high durability and stable accuracy during heavy duty cutting.
- Higher productivity can be achieved with the CAM-type tool changer that supports faster tool changing.

Easy operation for improving convenience to use NC system

- Easy operation for user's convenient machine operation.
- The EOP functions for the user-friendliness has improved the convenience of customers.



Basic Structure

Basic information

Basic Structure
Cutting
Performance

Detailed Information

Options
Applications
Diagrams
Specifications

Customer Support Service

The Mynx II series offers a wide line-up. High-rigidity machine structure provides high durability and stable accuracy during heavy duty cutting.

Travel distance (XxYxZ axis)

Mynx 5400 II, Mynx 5400/50 II

1020 x 550 x 530 mm
(40.2 x 21.7 x 20.9 inch)

Mynx 6500 II, Mynx 6500/50 II

1270 x 670 x 625 mm
(50.0 x 26.4 x 24.6 inch)

Mynx 7500 II, Mynx 7500/50 II

1525 x 770 x 625 mm
(60.0 x 30.3 x 24.6 inch)

Mynx 9500

2500 x 950 x 850 mm
(98.4 x 37.4 x 33.5 inch)

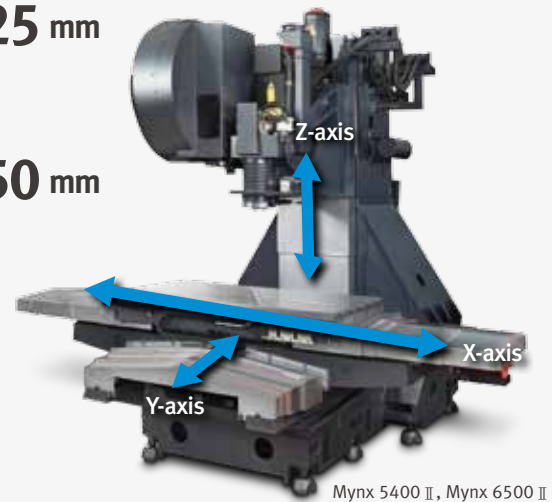

Mynx 5400 II, Mynx 6500 II



Axis System

Applied a highly rigid box guideway structure suitable for heavy cutting. The extended box-type guideways improve the machine durability as well as rigidity and stability.



Surface Finish

The surface of moving elements are coated with Rulon 142 material to reduce friction and stick-slip. This material is carefully hand-scraped to achieve optimum accuracy.

Models	Rapid traverser rate (X / Y / Z)
Mynx 5400 II	30 / 30 / 24 m/min (1181.1 / 1181.1 / 944.9 ipm)
Mynx 5400/50 II	
Mynx 6500 II	
Mynx 6500/50 II	
Mynx 7500 II	
Mynx 7500/50 II	
Mynx 9500	16 / 16 / 16 m/min (629.9 / 629.9 / 629.9 ipm)

Table

Mynx II series offers an optimized table for machine line up enabling to meet the user to handle a wider range of workpieces.

Wide machining area

Max weight on Table

Mynx 5400 II, Mynx 5400/50 II

1000 kg
(2204.6 lb)

Mynx 6500 II, Mynx 6500/50 II

1300 kg
(2866.0 lb)

Mynx 7500 II, Mynx 7500/50 II

1500 kg
(3306.9 lb)

Mynx 9500

3500 kg
(7716.1 lb)

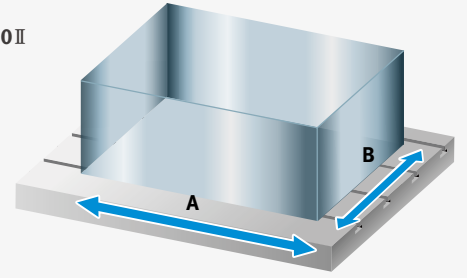

Table size (A x B)

Mynx 5400 II, Mynx 5400/50 II

1200 x 540 mm
(47.2 x 21.3 inch)

Mynx 6500 II, Mynx 6500/50 II

1400 x 670 mm
(55.1 x 26.4 inch)

Mynx 7500 II, Mynx 7500/50 II

1600 x 750 mm
(63.0 x 29.5 inch)

Mynx 9500

2500 x 950 mm
(98.4 x 37.4 inch)

Spindle

Users can select spindles of various driving systems and specifications according to the workpiece material.

Drive Systems

The Mynx II series spindles support Direct-driven, Belt-driven, Gear-driven, Built in-driven systems. Dual contact tool system support as standard.



Mynx 9500 Gear-driven spindles

Models	Taper	Standard	Optional
Mynx 5400 II *** Mynx 6500 II *** Mynx 7500 II ***	ISO #40	8000r/min (15/11 kW (20.1/14.8 Hp), 286.5 N·m (211.4 ft-lbs))	12000r/min (15.6 kW (20.9 Hp), 165.5 N·m (122.1 ft-lbs))
Mynx 5400/50 II Mynx 6500/50 II	ISO #50	6000r/min (15/11 kW (20.1/14.8 Hp), 286.4 N·m (211.4 ft-lbs))	6000r/min (18.5/15 kW (24.8/20.1 Hp), 307.2 N·m (226.7 ft-lbs)) 6000r/min* (30/18.5 kW (40.2/24.8 Hp), 617.4 N·m (455.6 ft-lbs))
Mynx 7500/50 II	ISO #50	6000r/min (18.5/15 kW (24.8/20.1 Hp), 307.2 N·m (226.7 ft-lbs))	6000r/min (22/18.5 kW (29.5/24.8 Hp), 365.5 N·m (269.7 ft-lbs)) 6000r/min* (30/18.5 kW (40.2/24.8 Hp), 617.4 N·m (455.6 ft-lbs)) 8000r/min (15/11 kW (20.1/14.8 Hp), 286.4 N·m (211.4 ft-lbs))
Mynx 9500	ISO #50	6000r/min* (30/18.5 kW (40.2/24.8 Hp), 617.4 N·m (455.6 ft-lbs))	10000r/min** (30/25 kW (40.2/33.5 Hp), 420 N·m (310.0 ft-lbs))

None : Belt-driven * : Gear-driven ** : Built in-driven *** : Direct-driven



Dual Contact Spindle

The system enables simultaneous dual-contact of tapered side using elastic deformation of the spindle and perfect gauge control.



Tool Changer

Basic information

- Basic Structure
- Cutting
- Performance

Detailed Information

- Options
- Applications
- Diagrams
- Specifications

Customer Support Service

Higher productivity can be achieved with the CAM-type tool changer that supports faster tool changing.

Tool Magazine

Chain type CAM magazine



Drum-type CAM magazine



Unit : ea

Models	Taper	Standard	Optional
Mynx 5400 II	ISO #40	30	40
Mynx 6500 II			
Mynx 7500 II			
Mynx 5400/50 II	ISO #50	24	-
Mynx 6500/50 II		24	30*
Mynx 7500/50 II		24	40*
Mynx 9500		30*	40*

None : Drum-type CAM magazine * : Chain type CAM magazine (Servo type)

Automatic tool changer

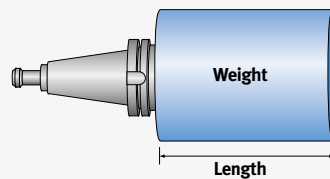

Models	Taper	Tool Change Time		Max. Tool Size	
		T-T-T	C-T-C	Length	Weight
Mynx 5400 II	ISO #40	1.3 s	3.7 s	300mm (11.8 inch)	8kg (17.6 lb)
Mynx 6500 II					
Mynx 7500 II					
Mynx 5400/50 II	ISO #50	2.5 s	5.5 s	350mm (13.8 inch)	15kg (33.1 lb)
Mynx 6500/50 II					
Mynx 7500/50 II					
Mynx 9500					



Cutting Performance

The heavy-duty machining performance of the Mynx II series spindles is the best in its class.

ISO #40

Result of cutting test on Mynx 5400 II (8000r/min, Direct, 15/11kW (20.1/14.8 Hp))

Face mill (ø80 mm, Cut edge count :6) Carbon steel (SM45C)			
Machining rate (cm ³ /min (inch ³ /min))	Spindle speed (r/min)	Feedrate (mm/min (ipm))	
374.4 (22.8)	500	1950 (76.8)	
Drill (ø50 mm) Carbon steel (SM45C)			
Machining rate (cm ³ /min (inch ³ /min))	Spindle speed (r/min)	Feedrate (mm/min (ipm))	
265.07 (16.2)	500	135 (5.3)	
Tap Carbon steel (SM45C)			
Tap size (mm (inch))	Spindle speed (r/min)	Feedrate (mm/min (ipm))	
M36 x P4.0 (M1.4 x P0.2)	265	1060 (41.7)	

* The results, indicated in this catalogue are provides as example. They may not be obtained due to differences in cutting conditions and environmental conditions during measurement.

ISO #50

Result of cutting test on Mynx 9500 (6000r/min, Gear, 30/18.5kW (40.2/24.8 Hp))

Face mill (ø125 mm,Cut edge count :8) Carbon steel (SM45C)			
Machining rate (cm ³ /min (inch ³ /min))	Spindle speed (r/min)	Feedrate (mm/min (ipm))	
756 (46.1)	464	1080 (42.5)	
Drill (ø85 mm) Carbon steel (SM45C)			
Machining rate (cm ³ /min (inch ³ /min))	Spindle speed (r/min)	Feedrate (mm/min (ipm))	
510 (31.1)	562	90 (3.5)	
Tap Carbon steel (SM45C)			
Tap size (mm (inch))	Spindle speed (r/min)	Feedrate (mm/min (ipm))	
M42 x P4.5 (M1.7 x P0.2)	100	450 (17.7)	

* The results, indicated in this catalogue are provides as example. They may not be obtained due to differences in cutting conditions and environmental conditions during measurement.



Standard / Optional Specifications

● Standard ○ Optional ✕ Not applicable

Basic information

Basic Structure
Cutting
Performance

Detailed Information

Options
Applications
Diagrams
Specifications

Customer Support Service

No.	Description	Features	Mynx 5400 II	Mynx 5400/50 II	Mynx 6500 II	Mynx 6500/50 II	Mynx 7500 II	Mynx 7500/50 II	Mynx 9500	
			Mynx 5400 II SIEMENS	Mynx 5400/50 II SIEMENS	Mynx 6500 II SIEMENS	Mynx 6500/50 II SIEMENS	Mynx 7500 II SIEMENS	Mynx 7500/50 II SIEMENS	Mynx 9500 SIEMENS	
1	Spindle	6000 r/min	Belt**	15/11 kW	●	○	○	○	○	○
2				18.5/15 kW	○	○	○	○	○	○
3			Gear*	22/18.5 kW	○	○	○	○	○	○
4				30/18.5 kW	○	○	○	○	○	○
5		8000 r/min	Direct	15/11 kW	●	○	○	○	○	○
6				Belt*	15/11 kW	○	○	○	○	○
7			Built in*	30/25 kW	○	○	○	○	○	○
8			12000 r/min	Direct*	15.6 kW	○	○	○	○	○
9	Spindle cooling system(Oil cooler)	6000 r/min	Belt*	○	○	○	○	○	○	
10				Gear*	○	○	○	○	○	○
11		8000 r/min	Direct*		○	○	○	○	○	
12			Belt*	○	○	○	○	○		
13		10000 r/min	Built in*	○	○	○	○	○		
14		12000 r/min	Direct*	○	○	○	○	○		
15	Magazine	Tool storage capacity	24ea	○	○	○	○	○	○	
16			30ea	○	○	○	○	○	○	
17				40ea	○	○	○	○	○	
18	Tool shank type	ISO #40	BIG PLUS BT40	○	○	○	○	○	○	
19			BIG PLUS CAT40	○	○	○	○	○	○	
20			BIG PLUS DIN40	○	○	○	○	○	○	
21		ISO #50	BIG PLUS BT50	○	○	○	○	○	○	
22			BIG PLUS CAT50	○	○	○	○	○	○	
23			BIG PLUS DIN50	○	○	○	○	○	○	
24	Coolant	FLOOD	0.15 MPa (0.4 kW)	○	○	○	○	○	○	
25			0.7 MPa (1.8 kW)	○	○	○	○	○	○	
26		TSC	None	○	○	○	○	○	○	
27			2 MPa (1.5kW)	○	○	○	○	○	○	
28			2 MPa (4.0 kW)	○	○	○	○	○	○	
29			7 MPa (5.5 kW)	○	○	○	○	○	○	
30		SHOWER	0.1 MPa (1.1 kW)	○	○	○	○	○	○	
31		Oil Skimmer	Belt type	○	○	○	○	○	○	
32	MQL		○	○	○	○	○	○		
33	Chip disposal	Chip pan		○	○	○	○	○	○	
34		Chip conveyor	Hinged type	○	○	○	○	○	○	
35			Magnetic scraper type	○	○	○	○	○	○	
36			Drum filter type	○	○	○	○	○	○	
37		Chip bucket		○	○	○	○	○	○	
38		Air blower		○	○	○	○	○	○	
39		Air gun		○	○	○	○	○	○	
40		Coolant gun		○	○	○	○	○	○	
41	Mist collector		○	○	○	○	○	○		
42	Precision machining option	Smart Thermal Compensation		○	○	○	○	○	○	
43		Linear scale	X / Y / Zaxis	○	○	○	○	○	○	
44		AICC I (40 block)		○	○	○	○	○	○	
45	AICC II (200 block)		○	○	○	○	○	○		
46	Measurement & Automation	Automatic tool measurement	TS27R	○	○	○	○	○	○	
47			OTS	○	○	○	○	○	○	
48		Automatic tool breakage detection		○	○	○	○	○	○	
49		Automatic workpiece measurement	OMP60	○	○	○	○	○	○	
50	Automatic front door with safety device		○	○	○	○	○	○		
51	Others	LED Work light		○	○	○	○	○	○	
52		3 color signal tower		○	○	○	○	○	○	
53		4th axis auxiliary device interface		○	○	○	○	○	○	
54		Tool load monitoring		○	○	○	○	○	○	
55		EZ Guide i		○	○	○	○	○	○	
56	Automatic power off		○	○	○	○	○	○		
57	Customized special option	Coolant level switch : Sensing level - Low / High		○	○	○	○	○	○	
58		Smart thermal control		○	○	○	○	○	○	
59		Graphite package		○	○	○	○	○	○	
60		Side auto door		○	○	○	○	○	○	
61		AWC		○	○	○	○	○	○	
62		ATC 48 Tools		○	○	○	○	○	○	
63		Aerospace solution package		○	○	○	○	○	○	
64		Bed flushing coolant		○	○	○	○	○	○	
65		Gear box SPD motor (A18 -> A22)		○	○	○	○	○	○	

*Spindle cooling system (Oil cooler) is standard **Spindle cooling system (Oil cooler) is option
* Please contact Doosan to select detail specifications.

Peripheral Equipment

Linear Scale option 49

Using the linear scale feedback system, accuracy of the machine can be further improved since the X, Y and Z axes can be controlled to correct positions.

Resolution : 0.001 mm



Smart thermal compensation (Mynx 9500 only)

Smart thermal compensation function fitted as standard optimizes machine accuracy of the spindle and structure by reducing the effects of heat build-up during extended periods of operation.

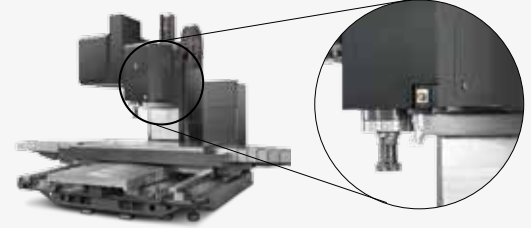

Chip conveyor option 40-42

Hinged type



Magnetic scraper type



Drum filter type



Chip conveyor type	Material	Description
Hinged type	Steel	Hinged belt chip conveyor, which is most commonly used for steel work [for cleaning chips longer than 30mm(1.2inch)], is available as an option.
Magnetic scraper type	Cast Iron	Magnetic scraper type chip conveyor, which is ideal for die-casting work [for cleaning small chips], is available as an option.
Drum filter type	Aluminium	Drum filter type chip conveyor, which is ideal for aluminium work [for filtering small chips], is available as an option.

Oil Cooler option

An oil cooler correlated to room temperature can be equipped for a long-term operation at high speed. Cooling oil circulates around the spindle bearings to prevent thermal error of the spindle and maintain machining accuracy.



4th axis auxiliary device interface option 59

Users who wish to set up a rotary axis on the table to increase application flexibility are encouraged to contact Doosan in advance.

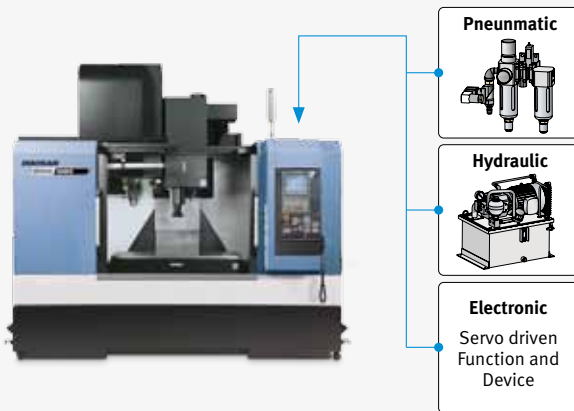

Hydraulic / Pneumatic fixture line option

The user should prepare pipelines for hydraulic / pneumatic fixtures whose detailed specifications should be determined by discussion with Doosan.

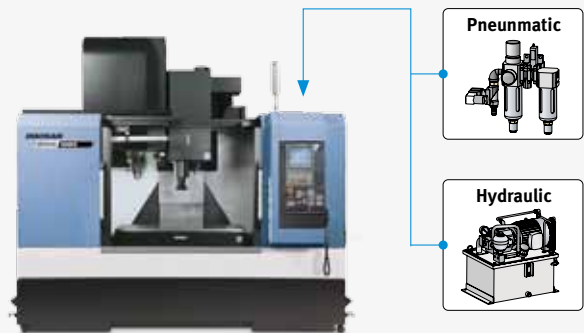

AWC system option

The optimized solution to realize compact automation system through automatic work-piece change system.

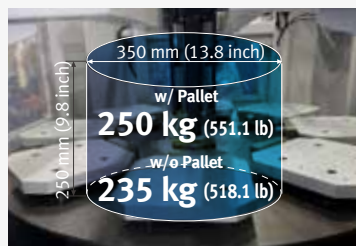



DOOSAN Fanuc i Plus

15 inch screen + New OP

DOOSAN Fanuc i Plus' operation panel enhances operating convenience by incorporating common-design buttons and layout, and features the Qwerty keyboard for fast and easy operation.

Basic information

- Basic Structure
- Cutting
- Performance

Detailed Information

- Options
- Applications
- Diagrams
- Specifications

Customer Support Service

DOOSAN Fanuc i Plus is optimized for maximizing customer productivity and convenience.



DOOSAN Fanuc i Plus

- 15 inch color display
- Intuitive and user-friendly design

USB & PCMCIA card QWERTY keyboard

- EZ-guide i standard
- Ergonomic operator panel
- 2MB Memory
- Hot key

iHMI Touch screen option

iHMI provides an intuitive interface that utilizes a touch screen for quick and easy operation and provides a variety of applications that can help machine operation.



• PLANNING

Tool information such as tool offset and tool life can be checked and set, and scheduler function is provided.

• MACHINING

MDI, EDIT, MEM, JOG screen can be changed by using touch function, and it is quick and easy to move to sub menu by using soft key.

• IMPROVEMENT

User can set up to record data for analysis and monitor the specific signals by setting up the maintenance and inspection function. Also user can add items.

• UTILITY

View and search PDF and TEXT files, create notes from text / images / drawings, and link to web pages. For users who are familiar with the DOOSAN Fanuc i Plus screen, the screen can be switched.



SIEMENS 828D

SIEMENS CNC optimized for DOOSAN machine tools maximizes users' productivity.

15.6 inch screen + New OP

The newly-designed operation panel enhances operating convenience by incorporating common-design buttons and layout, and features the Qwerty keyboard for fast and easy operation.



Conversational Convenient function

The machining monitoring function developed on the basis of the Shop Mill – an interactive machining support function of SIEMENS – provides users with cutting, servicing and maintenance screens for easy and convenient machine operation.



Smart function

Color highlighting is provided for each processing code function, and the calculator can be used easily by using the pocket calculator on display.



Shop Mill Part Programming

It helps to write the part program and shorten the writing time.



Advanced program language programGUIDE

Increases program flexibility, minimizing cycle time.



Simulation and machining contour monitoring

Simulation results with different views can be checked.



Side screen widget

Through the side widget, operator can easily monitor the current machining status.



Easy Operation Package

Basic information

Basic Structure
Cutting
Performance

Detailed Information

Options
Applications
Diagrams
Specifications

Customer Support Service

The software developed by Doosan's own technology provides numerous functions designed for convenient operation.

Adaptive Feed Control (AFC)



Function to control feedrate so that the cutting can be carried out at a constant load
(To adapt to the spindle load set up with constant load feedrate control function)

Tool Load Monitor



Function to automatically monitor tool load
(Different loads can be set for one tool according to M700 ~ M704)

Work Offset Setting

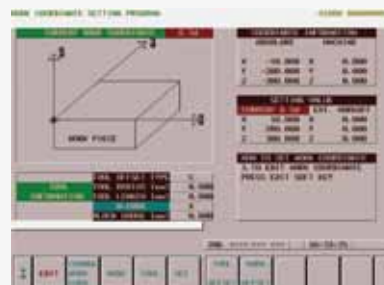

Function to configure various work offset settings

Sensor Status Monitor



Function to view sensor conditions of the machine

Tool Management



Function to manage tool information
[Tool information]
- Tool No. / Tool name
- Tool condition : normal, large diameter, worn/damaged, used for the first time, annual

Pattern Cycle & Engraving



Function to create frequently-used cutting programs automatically
- Pattern Cycle: creates a program for a pre-defined shape
- Engraving: creates a program for cutting a shape described with characters **option**

Alarm Guidance



Function to show detailed info on frequently triggered alarms and recommended actions

ATC Recovery



Function to view detailed info with recommended actions and to perform step-by-step operation manually (when an alarm is triggered during an ATC operation)

Spindle Power – Torque Diagram (FANUC)

Mynx 5400 II , Mynx 6500 II , Mynx 7500 II

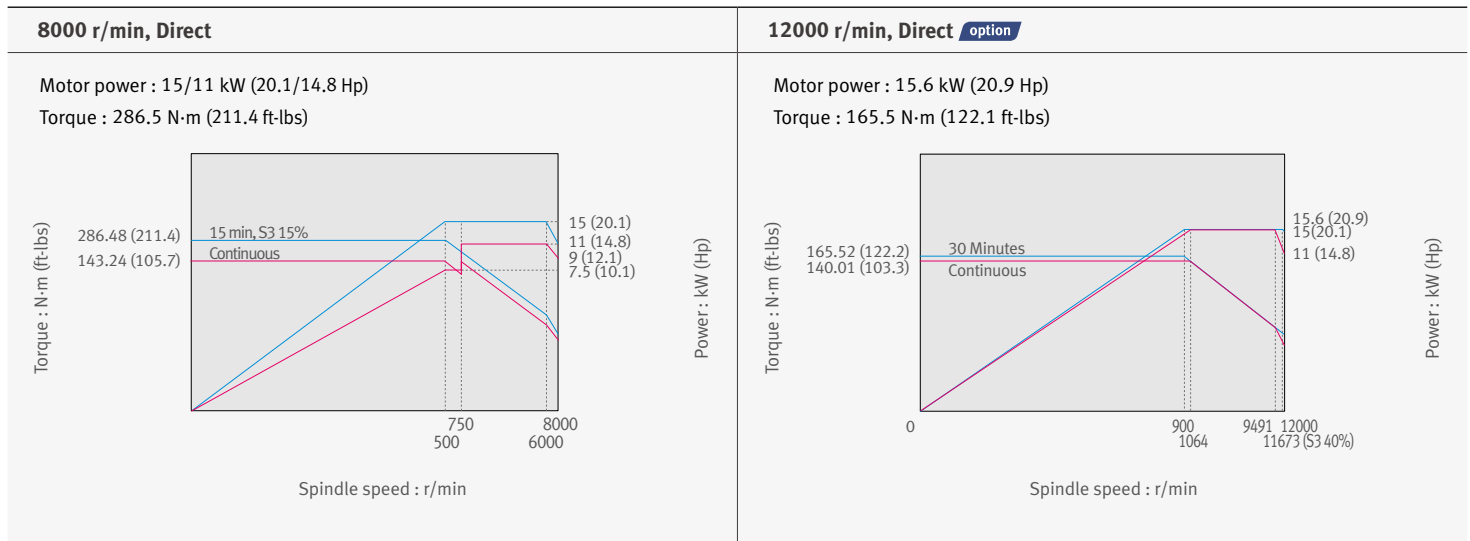

Mynx 5400/50 II , Mynx 6500/50 II

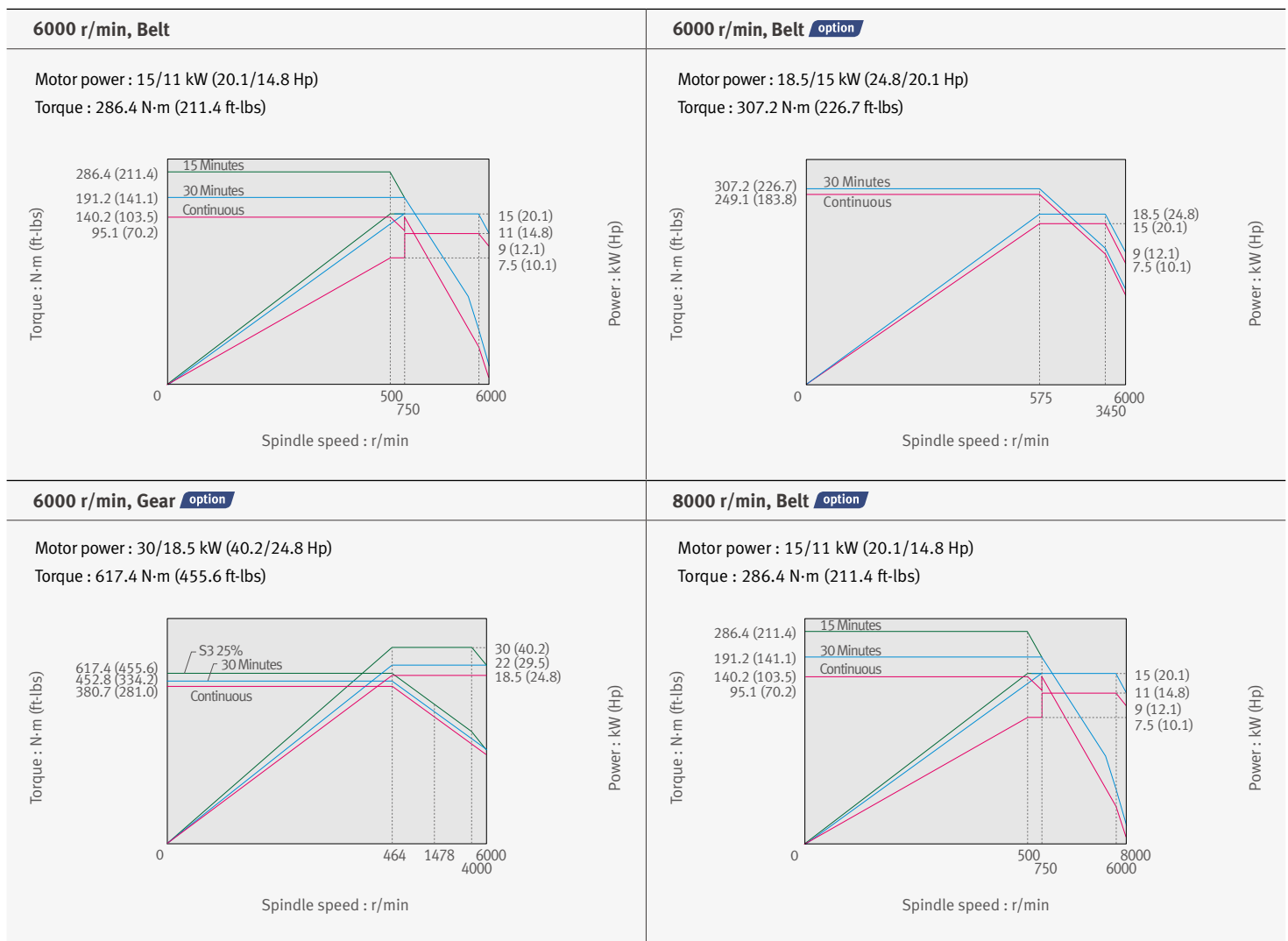

Spindle Power – Torque Diagram (FANUC)

Basic information

- Basic Structure
- Cutting
- Performance

Detailed Information

- Options
- Applications
- Diagrams
- Specifications

Customer Support Service

Mynx 7500/50 II

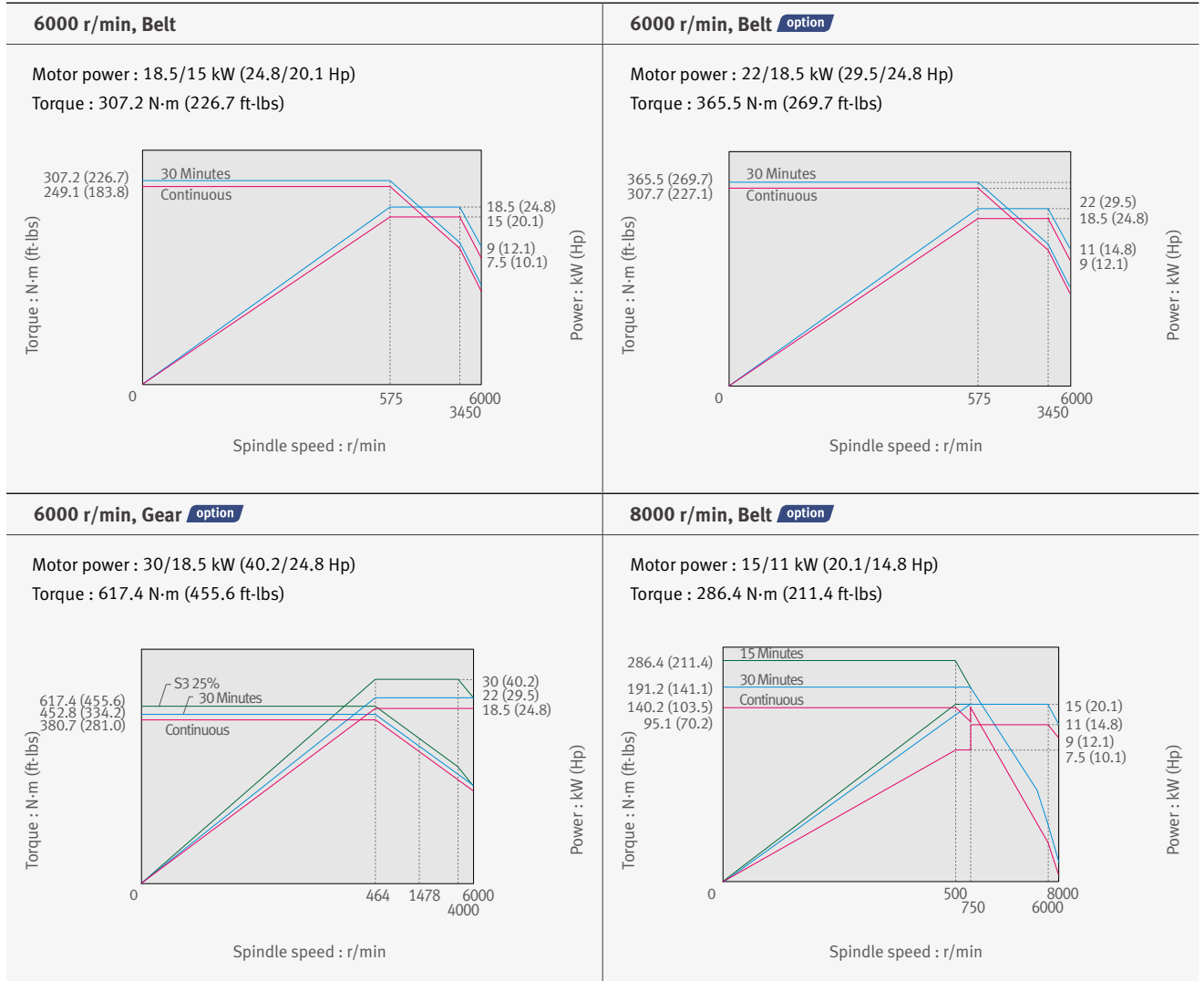

Mynx 9500

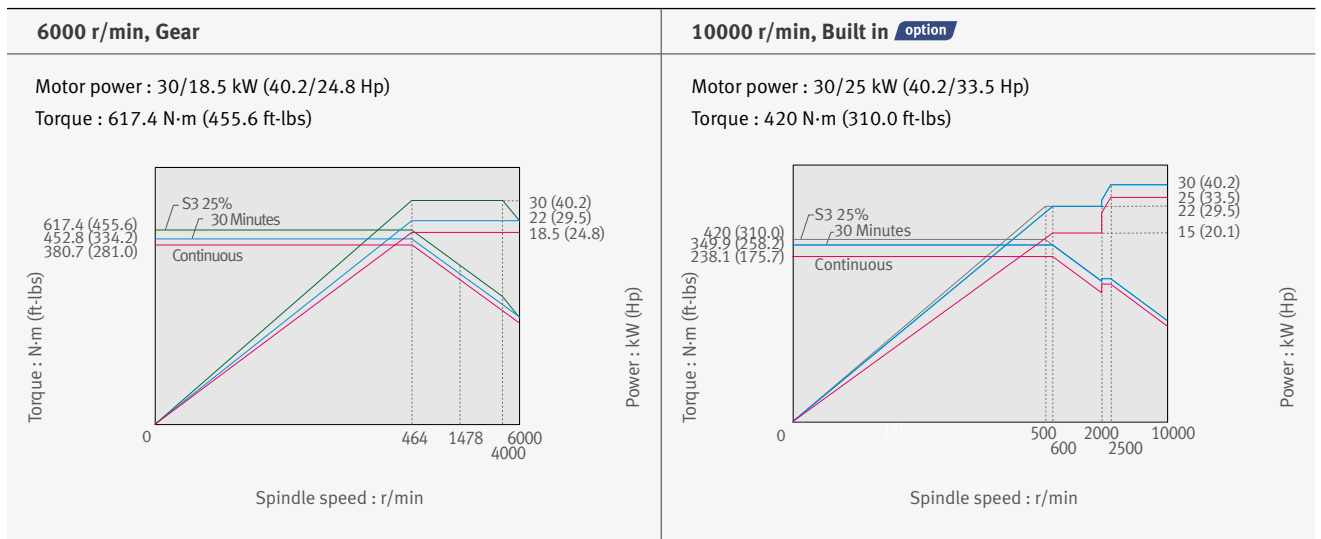

Spindle Power – Torque Diagram (SIEMENS)

12000 r/min, Direct

Motor power : 27.8 /18.5 kW (37.3/24.8 Hp)

Torque : 234.0 N·m (172.7 ft-lbs)

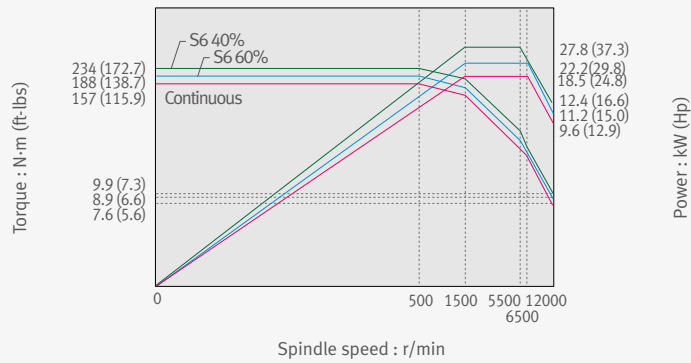

6000 r/min, Gear

Motor power : 27.8 /18.5 kW (37.3/24.8 Hp)

Torque : 760.0 N·m (560.9 ft-lbs)

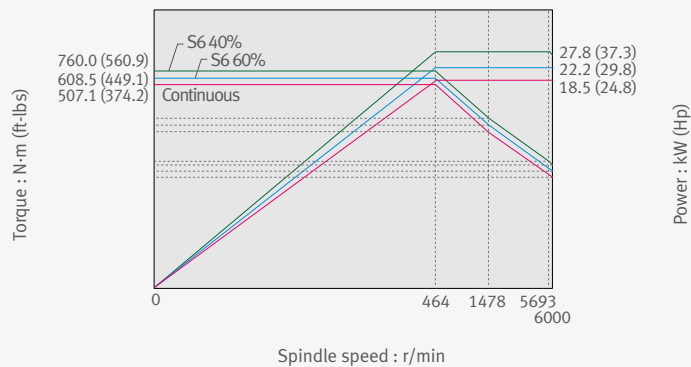

8000 r/min, Belt

Motor power : 27.8 /18.5 kW (37.3/24.8 Hp)

Torque : 234.0 N·m (172.7 ft-lbs)

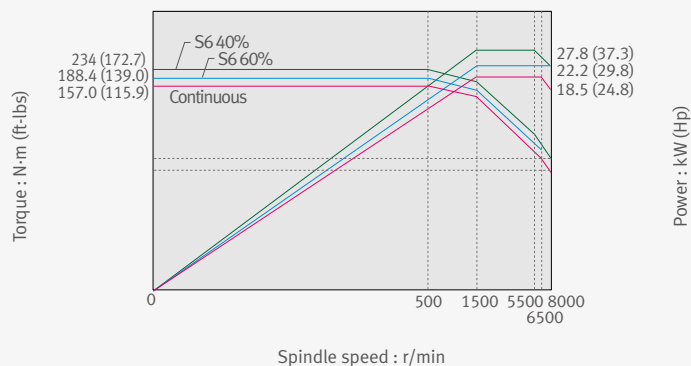

Spindle Power – Torque Diagram (HEIDENHAIN)

Basic information

- Basic Structure
- Cutting
- Performance

Detailed Information

- Options
- Applications
- Diagrams
- Specifications

Customer Support Service

Mynx 5400 /50 II, Mynx 6500/50 II, Mynx 7500/50 II

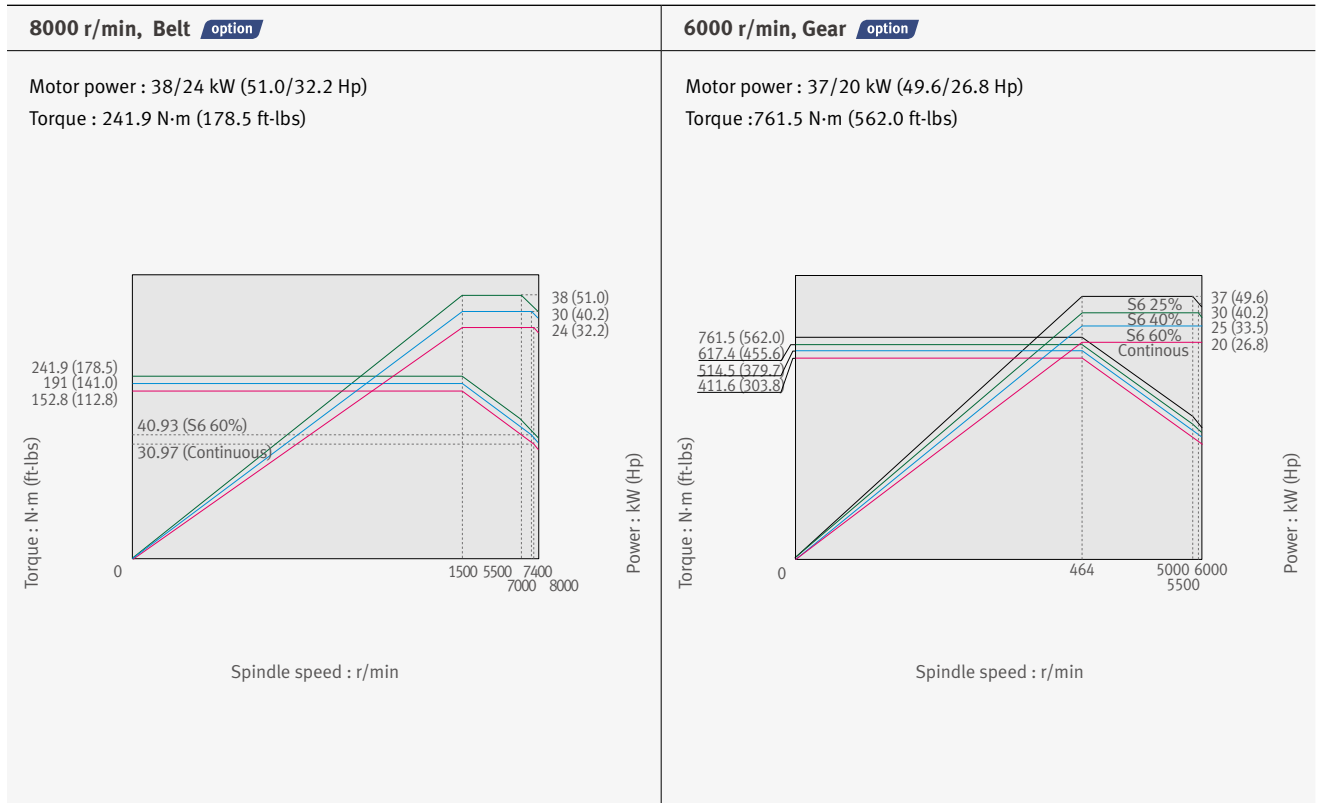

Mynx 9500

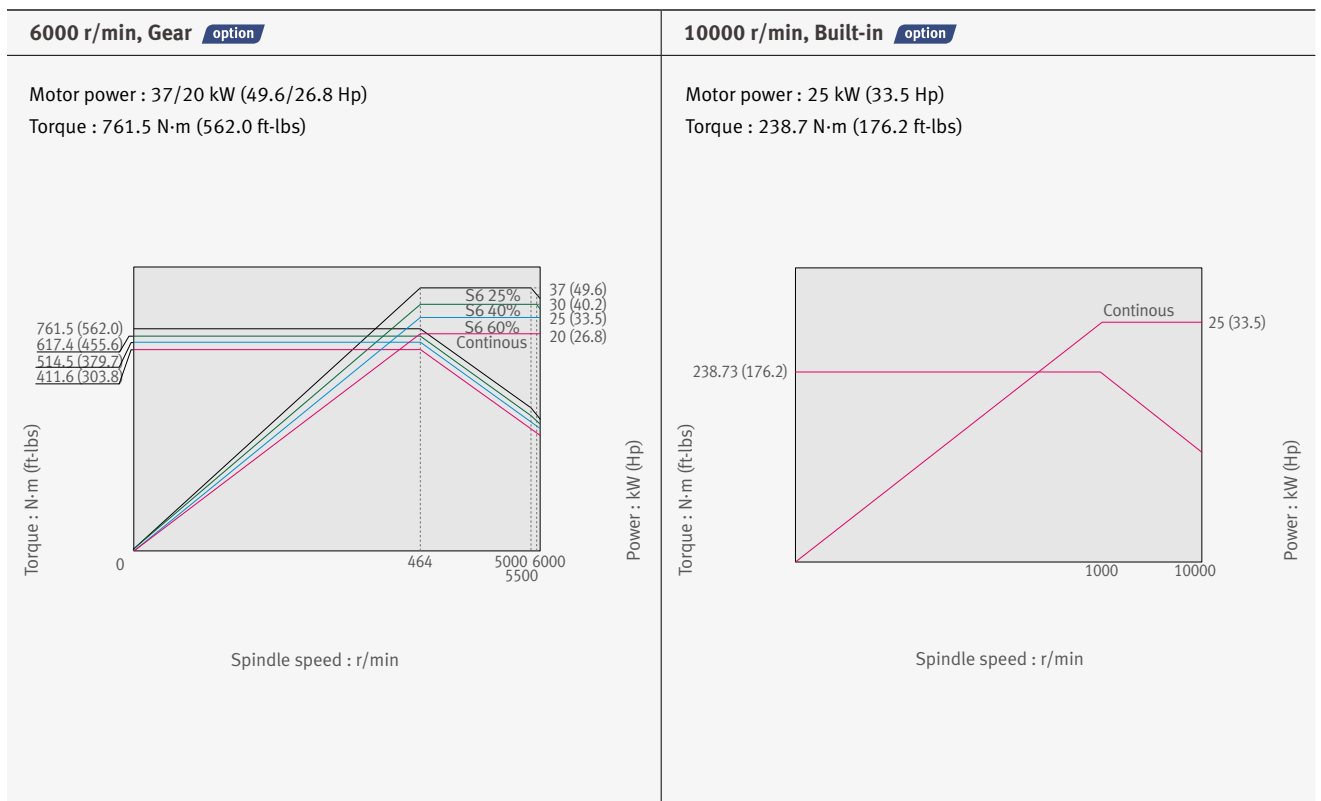

External Dimensions

Mynx II series

Top View

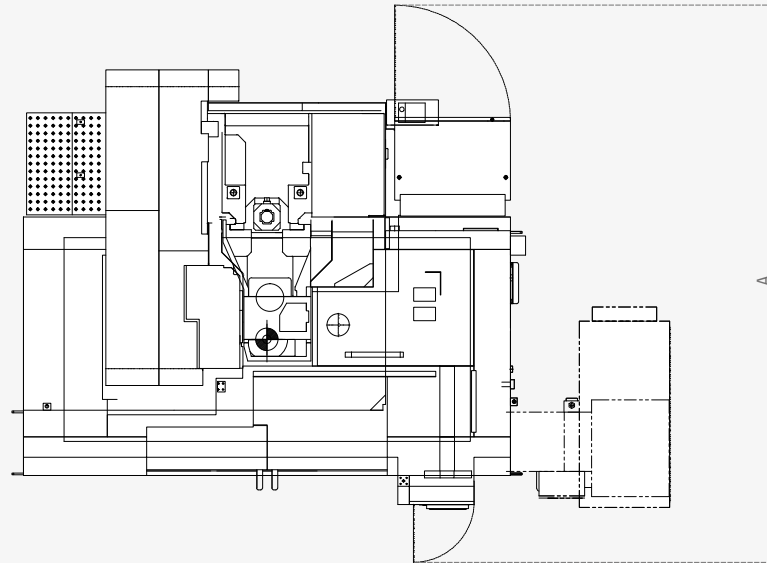

Front View

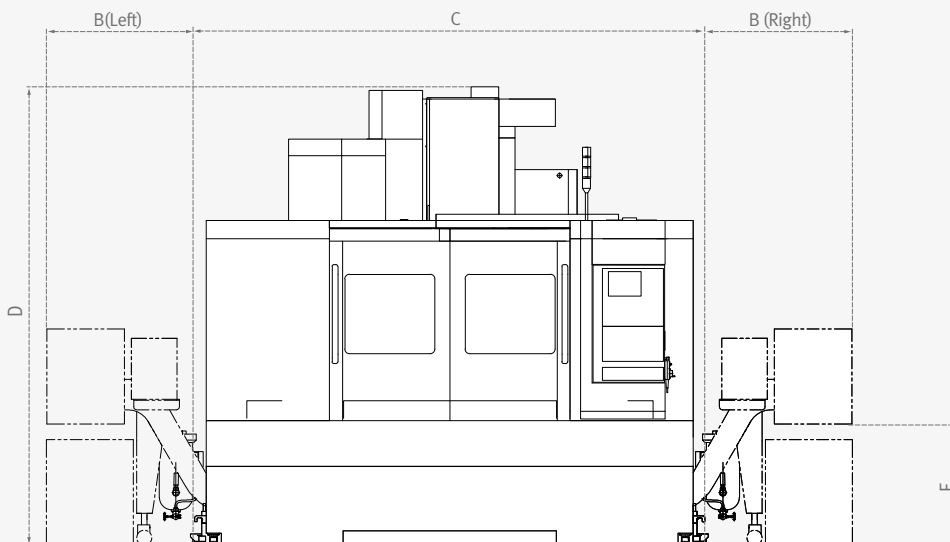

Unit : mm (inch)

	A (Max. machine length)	B* (Additional width to accommodate the side chip conveyor)	C (Max. machine width)	D (Max. machine height)	E (Height from the floor to the chip outlet)
Mynx 5400 II	3450 (135.8)	Left & Right : 930 (36.6)	3350 (131.9)	3020 (118.9)	830 (32.7)
Mynx 5400/50 II	3450 (135.8)	Left & Right : 930 (36.6)	3350 (131.9)	2920 (115.0)	830 (32.7)
Mynx 6500 II	3670 (144.5)	Left & Right : 930 (36.6)	3350 (131.9)	3110 (122.4)	830 (32.7)
Mynx 6500/50 II	3670 (144.5)	Left & Right : 930 (36.6)	3350 (131.9)	3020 (118.9)	830 (32.7)
Mynx 7500 II	4410 (173.6)	Left & Right : 1060 (41.7)	3900 (153.5)	3230 (127.2)	980 (38.6)
Mynx 7500/50 II	4680 (184.3)	Left & Right : 1060 (41.7)	4050 (159.4)	3300 (129.9)	980 (38.6)
Mynx 9500	5350 (210.6)	Left & Right : 1170 (46.1)	6560 (258.3)	3600 (141.7)	770 (30.3)

* Contact Doosan for more information to rear chip conveyor.

* Some peripheral equipment can be placed in other places

Table

Basic information

- Basic Structure
- Cutting
- Performance

Detailed Information

- Options
- Applications
- Diagrams
- Specifications

Customer Support Service

Mynx 5400 II , Mynx 5400/50 II

Unit : mm (inch)



Mynx 6500 II , Mynx 6500/50 II

Unit : mm (inch)

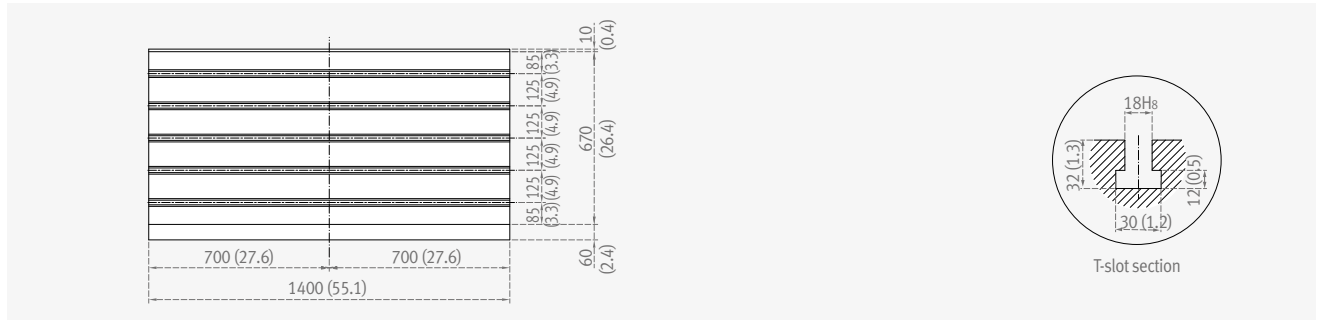

Mynx 7500 II , Mynx 7500/50 II

Unit : mm (inch)

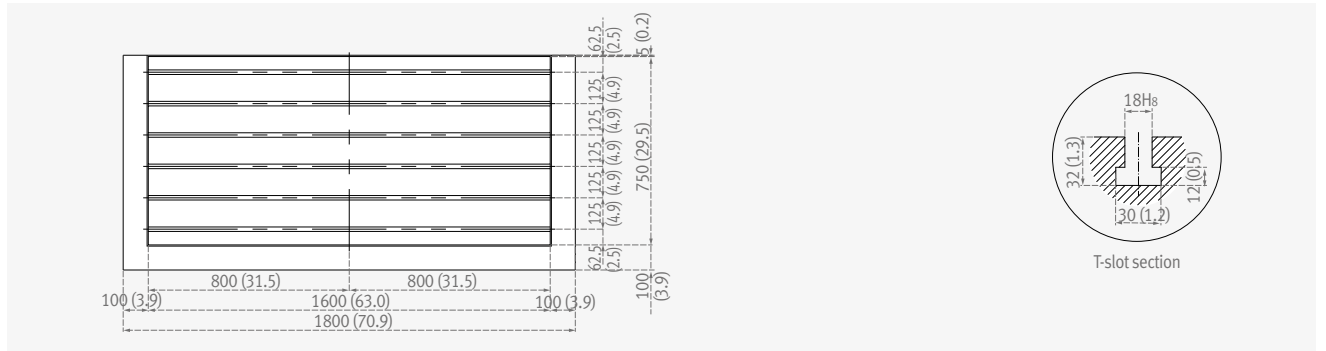

Mynx 9500

Unit : mm (inch)

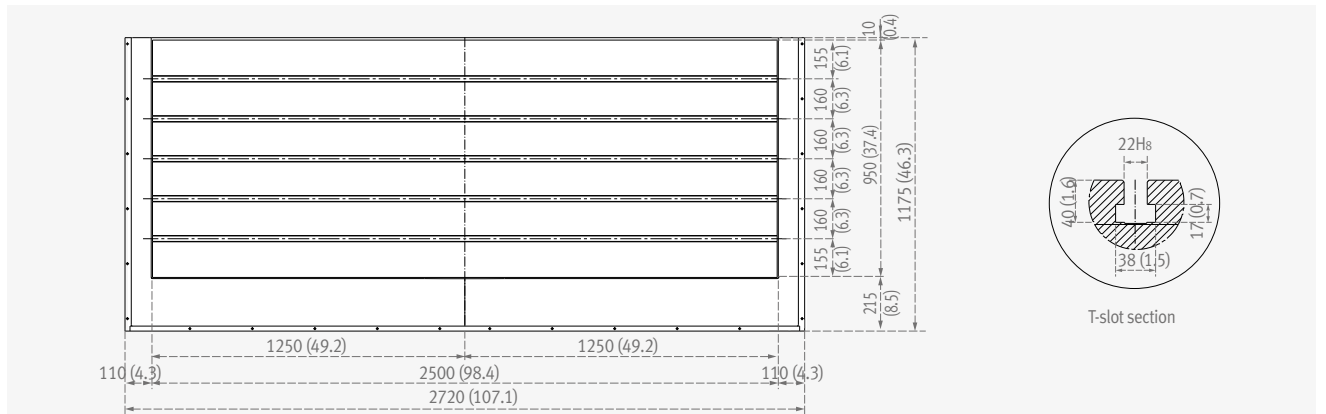

Machine Specifications



Description			Unit	Mynx 5400 II	Mynx 5400/50 II		
Travels	Travel distance	X axis	mm (inch)	1020 (40.2)			
		Y axis	mm (inch)	550 (21.7)			
		Z axis	mm (inch)	530 (20.9)			
	Distance from spindle nose to table top		mm (inch)	150 ~ 680 (5.9 ~ 26.8)	200 ~ 730 (7.9 ~ 28.7)		
Table	Table size		mm (inch)	1200 x 540 (47.2 x 21.3)			
	Table loading capacity		kg (lb)	1000 (2204.6)			
	Table surface type		mm (inch)	T-SLOT [4-125(4.9) x 18(0.7)H8]			
Spindle	Max. spindle speed	FANUC	Direct	r/min	8000 {12000}	-	
			Belt	r/min	-	6000 {6000} {8000}	
			Gear	r/min	-	{6000}	
			Built in	r/min	-	-	
		SIEMENS	Direct	r/min	12000	-	-
			Belt	r/min	-	8000	-
			Gear	r/min	-	{6000}	-
			Built in	r/min	-	-	-
		HEIDENHAIN	Direct	r/min	12000	-	-
			Belt	r/min	-	8000	-
			Gear	r/min	-	{6000}	-
			Built in	r/min	-	-	-
	Taper			-	ISO #40	ISO #50	
	Spindle power	FANUC	Direct	kW (Hp)	15/11(20.1/14.8) 15.6/15.6 (20.9/20.9)	-	
			Belt	kW (Hp)	-	15/11 (20.1/14.8) {18.5/15 (24.8/20.1)} {15/11 (20.1/14.8)}	
			Gear	kW (Hp)	-	{30/18.5 (40.2/24.8)}	
			Built in	kW (Hp)	-	-	
		SIEMENS	Direct	kW (Hp)	21.8/16.3 (29.2/21.9)	-	-
			Belt	kW (Hp)	-	20/18.5 (29.5/24.8)	-
			Gear	kW (Hp)	-	{27.8/18.5 (37.3/24.8)}	-
			Built in	kW (Hp)	-	-	-
		HEIDENHAIN	Direct	kW (Hp)	46/22 (61.7/29.5)	-	-
			Belt	kW (Hp)	-	38/24 (51.0/32.2)	-
			Gear	kW (Hp)	-	{37/20 (49.6/26.8)}	-
Built in			kW (Hp)	-	-	-	
Max. spindle torque	FANUC	Direct	N-m (ft-lbs)	286.5 (211.4) {165.5 (122.1)}	-		
		Belt	N-m (ft-lbs)	-	286.4 (211.2) {307.2 (226.7)} {286.4 (211.2)}		
		Gear	N-m (ft-lbs)	-	{617.4 (455.6)}		
		Built in	N-m (ft-lbs)	-	-		
	SIEMENS	Direct	N-m (ft-lbs)	150.1 (110.8)	-	-	
		Belt	N-m (ft-lbs)	-	298.3 (220.1)	-	
		Gear	N-m (ft-lbs)	-	{760 (560.9)}	-	
		Built in	N-m (ft-lbs)	-	-	-	
	HEIDENHAIN	Direct	N-m (ft-lbs)	292.8 (216.1)	-	-	
		Belt	N-m (ft-lbs)	-	241.9 (178.5)	-	
		Gear	N-m (ft-lbs)	-	{761.5 (562.0)}	-	
		Built in	N-m (ft-lbs)	-	-	-	
Feedrates	Rapid traverse rate	X axis	m/min (ipm)	30 (1181.1)			
		Y axis	m/min (ipm)	30 (1181.1)			
		Z axis	m/min (ipm)	24 (944.9)			
Automatic Tool Changer	Type of tool shank	Tool shank	-	BT 40 {CAT40/DIN40}	BT 50 {CAT50 / DIN50}		
		Pull stud	-	PS806	P50T-1 45deg		
	Tool storage capa.		ea	30 {40}	24		
	Max. tool diameter	Continous	mm (inch)	80 (3.1) {76 (3.0)}	125 (4.9)		
		Without Adjacent Tools	mm (inch)	125 (4.9)	220 (8.7)		
	Max. tool length		mm (inch)	300 (11.8)	350 (13.8)		
	Max. tool weight		kg (lb)	8 (17.6)	15 (33.1)		
	Max. tool moment		N-m (ft-lbs)	5.88 (4.3)	12.74 (9.4)		
	Tool selection				MEMORY RANDOM		
	Tool change time (Tool-to-tool)			sec	1.3	2.5	
	Tool change time (Chip-to-chip)			sec	3.7	5.5	
	Power source	Electric power supply (rated capacity)	Direct	FANUC	kVA	36.1 {40}	-
HEIDENHAIN				kVA	-	36.1 {40} {36.1}	
Belt			HEIDENHAIN	kVA	47 {56}	47 {56}	
			SIEMENS	kVA	-	48.7	
Gear			FANUC	kVA	-	{47.7}	
			HEIDENHAIN	kVA	-	-	
Built in		FANUC	kVA	-	-		
Compressed air supply			Mpa (psi)	0.54 (78.3)			
Tank capacity	Coolant tank capacity		L (gal)	380 (100.4)			
Machine Dimensions	Height		mm (inch)	2800 (110.2)	3015 (118.7)		
	Length		mm (inch)	2467 (97.1)	2467 (97.1)		
	Width		mm (inch)	3350 (131.9)	3350 (131.9)		
	Weight		kg (lb)	7000 (15432)	7200 (15873)		
Control	NC system		-	DOOSAN Fanuc i Plus, Fanuc 32i {SIEMENS S828D / HEIDENHAIN TNC 620}			

{ } : Option

Machine Specifications

Basic information

Basic Structure

Cutting

Performance

Detailed Information

Options

Applications

Diagrams

Specifications

Customer Support Service

Description		Unit	Mynx 6500 II	Mynx 6500/50 II	Mynx 7500 II	Mynx 7500/50 II	Mynx 9500				
Travels	Travel distance	X axis	1270 (50.0)		1525 (60.0)		2500 (98.4)				
		Y axis	670 (26.4)		770 (30.3)		950 (37.4)				
		Z axis	625 (24.6)		625 (24.6)		850 (33.5)				
	Distance from spindle nose to table top	mm (inch)	150 ~ 775 (5.9 ~ 30.5)	200 ~ 825 (7.9 ~ 32.5)	150 ~ 775 (5.9 ~ 30.5)	200 ~ 825 (7.9 ~ 32.5)	200 ~ 1000 (7.9 ~ 39.4)				
Table	Table size	mm (inch)	1400 x 670 (55.1 x 26.4)		1600 x 750 (63.0 x 29.5)		2500 x 950 (98.4 x 37.4)				
	Table loading capacity	kg (lb)	1300 (2866.0)		1500 (3306.9)		3500 (7716.2)				
	Table surface type	mm (inch)	T-SLOT [5-125(4.9) x 18(0.7)H8]		T-SLOT [6-125(4.9) x 18(0.7)H8]		T-SLOT [5-160(6.3) x 22(0.9)H8]				
Spindle	Max. spindle speed	FANUC	Direct	r/min	8000 (12000)	-	8000 (12000)	-			
			Belt	r/min	-	6000 {6000} {8000}	-	6000 {6000} {8000}	-		
			Gear	r/min	-	{6000}	-	{6000}	6000		
		SIEMENS	Built in	r/min	-	-	-	-	{10000}		
			Direct	r/min	12000	-	12000	-	-		
			Belt	r/min	-	8000	-	8000	-		
		HEIDENHAIN	Gear	r/min	-	{6000}	-	{6000}	{10000}		
			Built in	r/min	-	-	-	-	6000		
			Direct	r/min	12000	-	12000	-	-		
		Spindle power	Taper	FANUC	Direct	kW (Hp)	15/11(20.1/14.8) 15.6/15.6 (20.9/20.9)	-	15/11(20.1/14.8) 15.6/15.6 (20.9/20.9)	-	
					Belt	kW (Hp)	-	15/11 (20.1/14.8) {18.5/15 (24.8/20.1)} {15/11 (20.1/14.8)}	-	18.5/15 (24.8/20.1) {22/18.5 (29.5/24.8)} {15/11 (20.1/14.8)}	-
					Gear	kW (Hp)	-	{30/18.5 (40.2/24.8)}	-	{30/18.5 (40.2/24.8)}	30/18.5 (40.2/24.8)
SIEMENS	Built in			kW (Hp)	-	-	-	-	{30/25 (40.2/33.5)}		
	Direct			kW (Hp)	21.8/16.3 (29.2/21.9)	-	21.8/16.3 (29.2/21.9)	-	-		
	Belt			kW (Hp)	-	20/18.5 (26.8/24.8)	-	20/18.5 (26.8/24.8)	-		
HEIDENHAIN	Gear			kW (Hp)	-	{27.8/18.5 (37.3/24.8)}	-	{27.8/18.5 (37.3/24.8)}	-		
	Built in			kW (Hp)	-	-	-	-	{25 (33.5)}		
	Direct			kW (Hp)	46/22 (61.7/29.5)	-	46/22 (61.7/29.5)	-	-		
Max. spindle torque	Taper			FANUC	Belt	N-m (ft-lbs)	-	286.4 (211.2) {307.2 (226.7)} {286.4 (211.2)}	-	307.2 (226.7) {365.5 (269.5)} {286.4 (211.2)}	-
					Gear	N-m (ft-lbs)	-	{617.4 (455.6)}	-	{617.4 (455.6)}	617.4 (455.6)
					Built in	N-m (ft-lbs)	-	-	-	-	{420 (310.0)}
		SIEMENS	Direct	N-m (ft-lbs)	150.1 (110.8)	-	150.1 (110.8)	-	-		
			Belt	N-m (ft-lbs)	-	298.3 (220)	-	298.3 (220.1)	-		
			Gear	N-m (ft-lbs)	-	{760 (560.5)}	-	{760 (560.5)}	-		
		HEIDENHAIN	Built in	N-m (ft-lbs)	-	-	-	-	{238.8 (176.2)}		
			Direct	N-m (ft-lbs)	292.8 (216.1)	-	292.8 (216.1)	-	-		
			Belt	N-m (ft-lbs)	-	241.9 (178.5)	-	241.9 (178.5)	760 (560.5)		
		Feedrates	Rapid traverse rate	X axis	m/min (ipm)	30 (1181.1)				16 (629.9)	
					Y axis	30 (1181.1)				16 (629.9)	
					Z axis	24 (944.9)				16 (629.9)	
Automatic Tool Changer	Tool storage capa.			Tool shank	-	BT 40 {CAT40 /DIN40}	BT 50 {CAT50 /DIN50}	BT 40 {CAT40 /DIN40}	BT 50 {CAT50 /DIN50}	BT 50 {CAT50 /DIN50}	
					Pull stud	-	PS806	P50T-1 45deg	PS806	P50T-1 45deg	P50T-1 45deg
					ea	-	30 {40}	24 {30}	30 {40}	24 {40}	30 {40}
				Max. tool diameter	Continuous	mm (inch)	80 (3.1) {76 (3.0)}	125 (4.9)	80 (3.1) {76 (3.0)}	125 (4.9)	125 (4.9)
						Without Adjacent Tools	mm (inch)	125 (4.9)	220 (8.7)	125 (4.9)	230 (9.1)
					Max. tool length	mm (inch)	300 (11.8)	350 (13.8)	300 (11.8)	350 (13.8)	350 (13.8)
				Max. tool weight	kg (lb)	8 (17.6)	15 (33.1)	8 (17.6)	15 (33.1)	15 (33.1)	
				Max. tool moment	N-m (ft-lbs)	5.88 (4.3)	12.74 (9.4)	5.88 (4.3)	12.74 (9.4)	12.74 (9.4)	
				Tool selection	MEMORY RANDOM						
		Tool change time (Tool-to-tool)	sec	1.3	2.5	1.3	2.5	2.5			
		Tool change time (Chip-to-chip)	sec	3.7	5.5	3.7	6.0	6.0			
		Power source	Electric power supply (rated capacity)	Direct	FANUC	kVA	39.4 {45.1}	-	42.9 {56.9}	-	
FANUC	kVA				-	44.6 {39.4} {39.4}	-	47.3 {51.8} {42.9}	-		
HEIDENHAIN	kVA				47 {56}	47 {56}	47 {56}	40 {56}	-		
Belt	SIEMENS			kVA	-	-	-	60	-		
	FANUC			kVA	-	{48.4}	-	{51.8}	47.0		
Gear	HEIDENHAIN			kVA	-	-	-	-	-		
	Built in			FANUC	kVA	-	-	-	{54.2}		
Compressed air supply	Mpa (psi)	0.54 (78.3)									
Tank capacity	Coolant tank capacity	L (gal)	380 (100.4)				500 (132.1)				
Machine Dimensions	Height	mm (inch)	2825 (111.2)	3015 (118.7)	3185 (125.4)	3235 (127.4)	3598 (141.7)				
	Length	mm (inch)	2692 (106.0)	2629 (103.5)	3900 (153.5)	3900 (153.5)	4315 (169.9)				
	Width	mm (inch)	3350 (131.9)	3350 (131.9)	4050 (159.4)	4050 (159.4)	6480 (255.1)				
	Weight	kg (lb)	9000 (19842)	9200 (20283)	13500 (29762)	13500 (29762)	23000 (50706)				
Control	NC system	-	DOOSAN Fanuc i Plus, Fanuc 32i {SIEMENS S828D} / HEIDENHAIN TNC 620								

CNC Specifications

● Standard ○ Optional X Not applicable

FANUC

No.	Division	Item	Spec.	DOOSAN Fanuc i Plus	Fanuc 32i	
1	Axes control	Controlled axes	3 (X, Y, Z)	X, Y, Z	X, Y, Z	
2		Least command increment	0.001 mm / 0.0001"	●	●	
3		Least input increment	0.001 mm / 0.0001"	●	●	
4		Stored pitch error compensation	Pitch error offset compensation for each axis	X	●	
5		Interpolation type pitch error compensation		●	○	
6	Interpolation & Feed function	2nd reference point return	G30	●	●	
7		3rd / 4th reference return		●	○	
8		Inverse time feed		●	○	
9		Cylindrical interpolation	G07.1	●	○	
10		Automatic corner override	G62	●	○	
11		Manual handle feed	Max. 3unit	1 unit	1 unit	
12		Manual handle feed rate	x1, x10, x100 (per pulse)	●	●	
13		Manual handle retrace		○	○	
14		Handle interruption		●	●	
15		AICC II	200 BLOCK	●	○	
16		Fine Surface Machining	Look-ahead block no. is Max. 200 - AI contour control II+ - Smooth tolerance control+ - Jerk control - Machining quality level adjustment function	●	X	
17	Spindle & M-code function	M- code function		●	●	
18		Retraction for rigid tapping		●	●	
19		Rigid tapping	G84, G74	●	●	
20	Tool function	Number of tool offsets	400 ea	400ea	○	
21		Tool nose radius compensation	G40, G41, G42	●	●	
22		Tool length compensation	G43, G44, G49	●	●	
23		Tool life management		●	●	
24		Addition of tool pairs for tool life management		●	○	
25		Tool offset	G45 - G48	●	○	
26	Programming & Editing function	Custom macro		●	●	
27		Macro executor		●	●	
28		Macro executor + C language executor		●	X	
29		Fanuc picture executor		●	X	
30		Extended part program editing		●	●	
31		Part program storage	512KB(1280m)	X	○	
32		Part program storage	2MB(5120m)	5120m	○	
33		Inch/metric conversion	G20 / G21	●	●	
31		Optional block skip	9 BLOCK	●	○	
32		Optional stop	M01	●	●	
33		Playback function		●	○	
34		Number of Registered programs	1000 ea	1000ea	○	
35		Tilted working plane indexing command	G68.2	○	○	
36		Tilted working plane indexing function	Programming TWP command on guidance window	○	○	
37		OTHERS FUNCTIONS (Operation, setting & Display, etc)	Embedded Ethernet		●	●
38			Graphic display	Tool path drawing	●	●
39			Loadmeter display		●	●
40			MDI / DISPLAY unit	15" color LCD	●	●
41	15" color LCD with Touch Panel			○	X	
42	Cs contouring control			●	X	
43	Memory card interface			●	●	
44	USB memory interface		Only Data Read & Write	●	●	
45	Operation history display			●	●	
46	DNC operation with memory card			●	●	
47	Optional angle chamfering / corner R			●	●	
48	Run hour and part number display			●	●	
49	High speed skip function			●	○	
50	Polar coordinate command		G15 / G16	●	○	
43	Programmable mirror image		G50.1 / G51.1	●	○	
44	Scaling		G50, G51	●	○	
45	Single direction positioning		G60	●	○	
46	Pattern data input			●	○	
47	Machine alarm diagnosis			●	X	
48	CNC screen display			●	●	
49	CNC screen dual display function			●	●	
50	One touch macro call		G15 / G16	●	○	
51	Machining quality level adjustment		G50.1 / G51.1	●	○	
52	EZ Guide i (Conversational Programming Solution)		G50, G51	● ¹⁾	○	
53	iHMI with Machining Cycle	G60	○ ²⁾	X		
54	MANUAL GUIDE i		X	○		

1) Only with 15" LCD standard
2) Only with 15" Touch LCD standard

Basic information

Basic Structure
Cutting
Performance

Detailed Information

Options
Applications
Diagrams
Specifications

Customer Support Service



No.	Division	Item	Spec.	Mynx9500	Mynx5400/ 6500/7500	
				S840Dsl	S828D	
1	Axes control	Controlled axes	3 axes	X, Y, Z	X, Y, Z	
2			4 axes	○	○	
3			5 axes	○	○	
4		Additional controlled axes	Max. 31 axes in total(S840Dsl) /Max. 5 axes in total(S828D)	○	○	
5		Simultaneously controlled axes	Positioning(G00)/Linear interpolation(G01) : 3 axes Circular interpolation(G02, G03) : 2 axes	●	●	
6				Positioning(G00)/Linear interpolation(G01) : 4 axes Circular interpolation(G02, G03) : 2 axes	X	X
7				Positioning(G00)/Linear interpolation(G01) : 5 axes Circular interpolation(G02, G03) : 2 axes	X	X
8				Backlash compensation	●	●
9				Leadscrew error compensation	●	●
10		Measuring system error compensation	●	●		
11		Feedforward control	velocity-dependent	●	●	
12		Follow up mode		●	●	
13		Programmable acceleration		●	●	
14		Emergency stop / overtravel		●	●	
15		Least command increment	0.001mm (0.0001 inch)	●	●	
16		Least input increment	0.001mm (0.0001 inch)	●	●	
17			0.0001mm (0.0001 inch)	X	X	
18		Maximum commandable value	±99999.999mm (±3937 inch)	●	●	
19		Machine lock (PRT)	All axes	●	●	
20		Position switching signals/cam controller		●	X	
21		Absolute encoder		●	●	
22		Travel to fixed stop with Force Control		○	○	
23	Interpolation & Feed functions	Reference point return	G75 FP=1	●	●	
24		2nd reference point return	G75 FP=2	●	●	
25		3rd / 4th reference return	G75 FP=3, 4	●	●	
26		Linear interpolation	Max. 4	●	●	
27		Circular interpolation	G02, G03	●	●	
28		Inverse time feedrate	G93	●	●	
29		Helical interpolation		●	●	
30		Universal interpolator NURBS		●	●	
31		Spline interpolation (A, B and C splines)		●	○	
32		Dwell	G04	●	●	
33		Separate path feed for corners and chamfers		●	●	
34		Reposition		●	●	
35		Acceleration with Jerk limitation		●	●	
36		Compressor for 3-axis machining		●	●	
37		Compressor for 5-axis machining		X	X	
38		Temperature compensation		X	X	
39	Spindle Functions	Spindle override	50 - 120 %	●	●	
40		Automatic gear state selection		●	●	
41		Oriented spindle stop		●	●	
42		Tapping with compensating chuck/rigid tapping		●	●	

No.	Division	Item	Spec.	Mynx9500	Mynx5400/ 6500/7500
				S840Dsl	S828D
43	Tool Functions	Tool radius compensations in plane	With approach and retract strategies	●	●
44			With transition circle/ellipse on outer edges	●	●
45		3D Tool radius compensation		○	○
46		Number of tools/cutting edges in tool list	256/512	X	X
47			600/1500	●	●
48		Tool length compensation		●	●
49		Operation with tool management		●	●
50		Monitoring of tool life and workpiece count		●	●
51	Magazine list		●	●	
52	Programming & Editing functions	Number of levels for skip blocks		8	8
53		Number of levels for skip blocks, maximum 10		X	X
54		Program functions			
55		• Dynamic preprocessing memory FIFO		●	●
56		Program editor			
57		• Programming graphics/free contour input (contour calculator)		●	●
58		• Screens for 1/2/3-point contours (contour definition programming)		●	●
59		• Support for parameter input Animated Elements		●	●
60		• Shopturn/ShopMill Machining step programming		●	●
61		Technology cycles for drilling/milling		●	●
62		JOG			
63		• Handwheel selection		●	●
64		• Switchover: inch/metric		●	●
65		• Manual measurement of zero/work offset		●	●
66		• Manual measurement of tool offset		●	●
67	• Automatic tool/workpiece measurement		●	●	
68	• Reference point approach, automatic/via CNC program		●	●	
69	Automatic				
70	• Execution from USB interface on operator panel front		●	●	
71	• Execution from HMI memory on NCU CF card		●	X	
72	• Execution from network drive		●	○	
73	• Execution from Hard disk (PCU50.5)		○	X	
74	Preset				
75	• Set actual value		●	●	
76	10.4" color display		X	X	
77	15.0" color display		○	X	
78	19.0" color display		X	X	
79	15.6" color display with touch screen		●	●	
80	18.5" color display with touch screen		○	X	
81	Operating software languages		X		
82	Alarms and messages		●	●	
83	Remote Control System (RCS) remote diagnostics				
84	• RCS Host remote diagnostics function		○	○	
85	• RCS Commander (viewer function)		●	●	
86	Integrated service planner for the monitoring of service intervals		●	●	
87	Automatic measuring cycles		●	○	
88	Easy Extend		X	●	
89	Contour handwheel		○	○	
90	Integrate screens in SINUMERIK Operate with SINUMERIK Integrate Run MyScreens		○	○	
91	Cross-mode actions (ASUPs and synchronized actions in all operating modes)		○	○	
92	Collision avoidance (machine, working area)		○	○	
93	MDynamics 5-axis		X	X	
	Others functions (Operation, setting & Display, etc)				

Basic information

Basic Structure
Cutting
Performance

Detailed Information

Options
Applications
Diagrams
Specifications

Customer Support Service

HEIDENHAIN

No.	Division	Item	Spec.	TNC 620		
				Mynx 5400 II, Mynx 5400/50 II Mynx 6500 II, Mynx 6500/50 II Mynx 7500 II, Mynx 7500/50 II	Mynx 9500	
1	Axes	Controlled axes	3 axes	X, Y, Z	X, Y, Z	
2			4 axes	○	○	
3		Controlled axes	Max. 12 axes in total	○	○	
4		Least command increment	0.0001 mm (0.0001 inch), 0.0001°	●	●	
5		Least input increment	0.0001 mm (0.0001 inch), 0.0001°	●	●	
6		Maximum commandable value	±99999.999mm (±3937 inch)	●	●	
7		Axis feedback control	Double-speed control loops for high-frequency spindles and torque/linear motors	○	○	
8		MDI / DISPLAY unit	15.1 inch TFT color flat panel	●	●	
9			19 inch TFT color flat panel	○	○	
10		Program memory for NC programs	SSDR	21GB	21GB	
11		Block processing time		0.5 ms	0.5 ms	
12		Cycle time for path interpolation	CC 61xx	3 ms	3 ms	
13		Encoders	Absolute encoders	EnDat 2.2	EnDat 2.2	
14		Commissioning and diagnostics	Data interfaces	Ethernet interface	●	●
15				USB interface (USB 2.0)	●	●
16	Machine functions	Look-ahead	Intelligent path control by calculating the path speed ahead of time (max. 1024 blocks.)	●	●	
17		HSC filters		●	●	
18		Switching the traverse ranges		●	●	
19	User functions	Program input	According to ISO	●	●	
20			With smarT.NC	●	●	
21		Position entry	Nominal positions for lines and arcs in Cartesian coordinates	●	●	
22			Incremental or absolute dimensions	●	●	
23			Display and entry in mm or inches	●	●	
24			Display of the handwheel path during machining with handwheel superimpositioning	●	●	
25			Paraxial positioning blocks	●	●	
26		Tool compensation	In the working plane and tool length	●	●	
27			Radius-compensated contour lookahead for up to 99 blocks (M120)	●	●	
28			Three-dimensional tool radius compensation	●	●	
29		Tool table	Central storage of tool data	●	●	
30			Multiple tool tables with any number of tools	●	●	
31		Cutting-data table	Calculation of spindle speed and feed rate based on stored tables	●	●	
32		Constant contouring speed	relative to the path of the tool center or to the tool's cutting edge	●	●	
33		Parallel operation	Creation of a program while another program is being run	●	●	
34		Tilting the working plane with Cycle 19		○	○	
35		Tilting the working plane with the PLANE function		○	○	
36		Manual traverse in tool-axis direction	after interruption of program run	●	●	
37		Function TCPM	Retaining the position of tool tip when positioning tilting axes	●	●	

● Standard ○ Optional X Not applicable

No.	Division	Item	Spec.	TNC 620			
				Mynx 5400 II, Mynx 5400/50 II Mynx 6500 II, Mynx 6500/50 II Mynx 7500 II, Mynx 7500/50 II	Mynx 9500		
38	User functions	Rotary table machining	Programming of cylindrical contours as if in two axes	○	○		
39			Feed rate in distance per minute	○	○		
40			FK free contour programming	for workpieces not dimensioned for NC programming	●	●	
41			Program jumps	Subprograms and program section repeats	●	●	
42				Calling any program as a subprogram	●	●	
43			Program verification graphics	Plan view, view in three planes, 3-D view	●	●	
44			Programming graphics	3-D line graphics	●	●	
45			Program-run graphics	(plan view, view in three planes, 3-D view)	●	●	
46			Datum tables	Saving of workpiece-specific datums	●	●	
47			Preset table	Saving of reference points	●	●	
48			Freely definable table	after interruption of program run	●	●	
49			Returning to the contour	With mid-program startup	●	●	
50				After program interruption (with the GOTO key)	●	●	
51			Autostart		●	●	
52			Actual position capture		●	●	
53			Enhanced file management		●	●	
54			Context-sensitive help for error messages		●	●	
55			TNCguide	Browser-based, context-sensitive helpsystem	●	●	
56			Calculator		●	●	
57			Entry of text and special characters		●	●	
58			Comment blocks in NC program		●	●	
59			"Save As" function		●	●	
60			Structure blocks in NC program		●	●	
61			Entry of feed rates	FU (feed per revolution)	●	●	
62				FZ (tooth feed per revolution)	●	●	
63				FT (time in seconds for path)	●	●	
64				FMAXT (only for rapid traverse pot: time in seconds for path)	●	●	
65			Dynamic collision monitoring (DCM)		○	○	
66			Fixture monitoring		○	○	
67			Processing DXF data		○	○	
68			Global program settings (GS)		○	○	
69			Adaptive feed control (AFC)		○	○	
70		KinematicsOpt	Automatic measurement and optimization of machine kinematics	○	○		
71		KinematicsComp	Three-dimensional compensation	○	○		
72		3D-ToolComp	Dynamic 3-D tool radius compensation	○	○		
73	Fixed cycles	Working plane	Cycle 19	○	○		
74			Cylinder surface	Cycle 27	○	○	
75			Cylinder surface slot milling	Cycle 28	○	○	
76			Cylinder surface ridge milling	Cycle 29	○	○	
77	Cycles for automatic workpiece	Calibrate TS		●	●		
78	inspection	Calibrate TS length		●	●		
79			Measure axis shift		●	●	
80			Save kinematics		○	○	
81			Measure kinematics		○	○	
82			Preset compensation		○	○	
83	Options	Software option 1	Rotary table machining	Programming of cylindrical contours as if in two axes	○	○	
				Feed rate in mm/min			
			Coordinate transformation	Tilting the working plane, PLANE function			
		Interpolation	Circular in 3 axes with tilted working plane				
84		Software option 2	3-D machining		3-D tool compensation through surface normal vectors	○	○
					Tool center point management (TCPM)		
				Keeping the tool normal to the contour			
			Tool radius compensation normal to the tool direction				
	Interpolation	Line in 5 axes (subject to export permit)					
			Spline: execution of splines (3rd degree polynomial)				

Responding to Customers Anytime, Anywhere

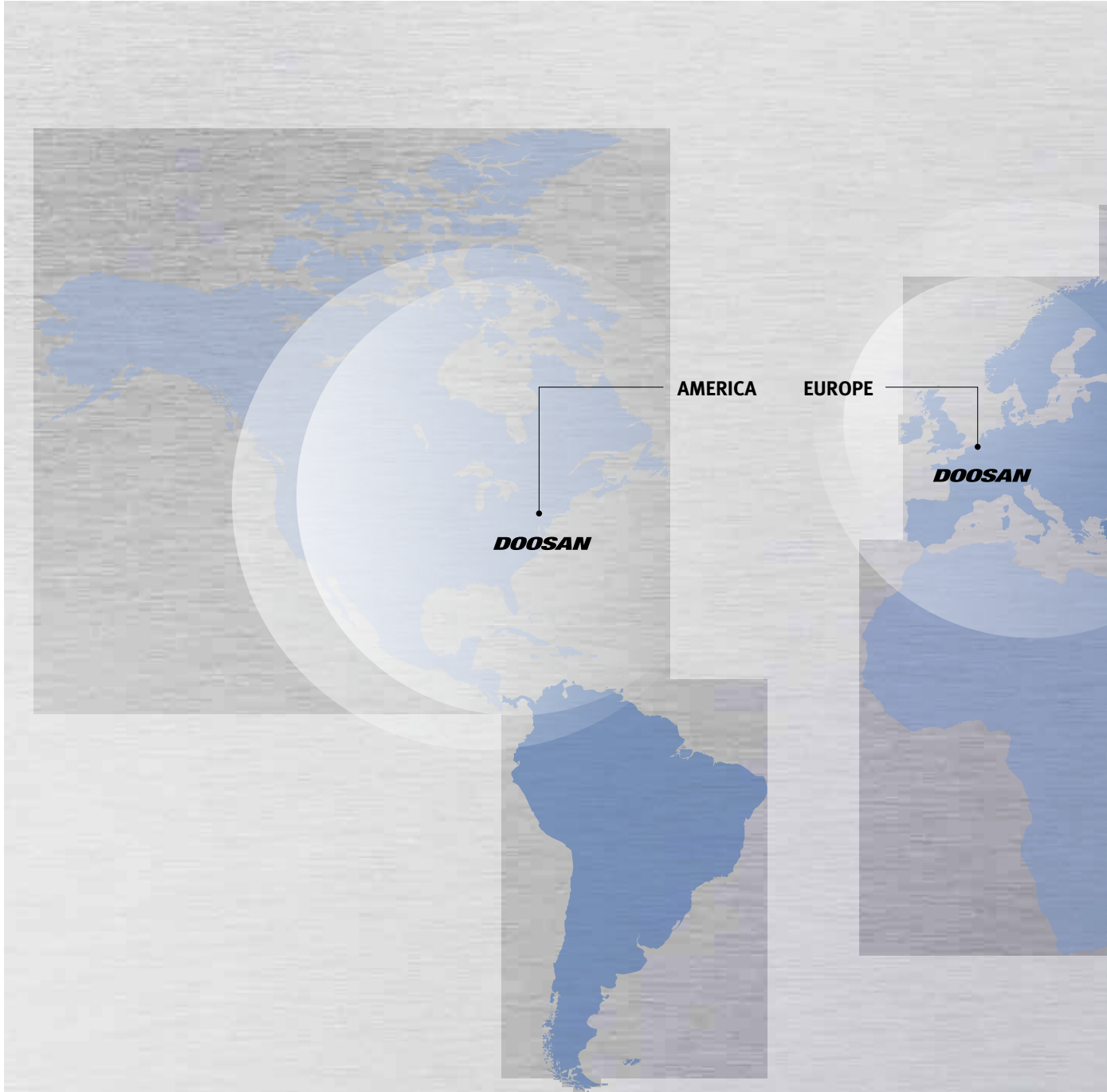

Global Sales and Service Support Network

Corporations	Dealer Networks	Technical Centers	Service Post	Factories
4	164	51	198	3

Technical Center: Sales Support, Service Support, Parts Support

Doosan Machine Tools' Global Network, Responding to Customer's Needs nearby, Anytime, Anywhere

Doosan machine tools provides a system-based professional support service before and after the machine tool sale by responding quickly and efficiently to customers' demands.

By supplying spare parts, product training, field service and technical support, we can provide top class support to our customers around the world.

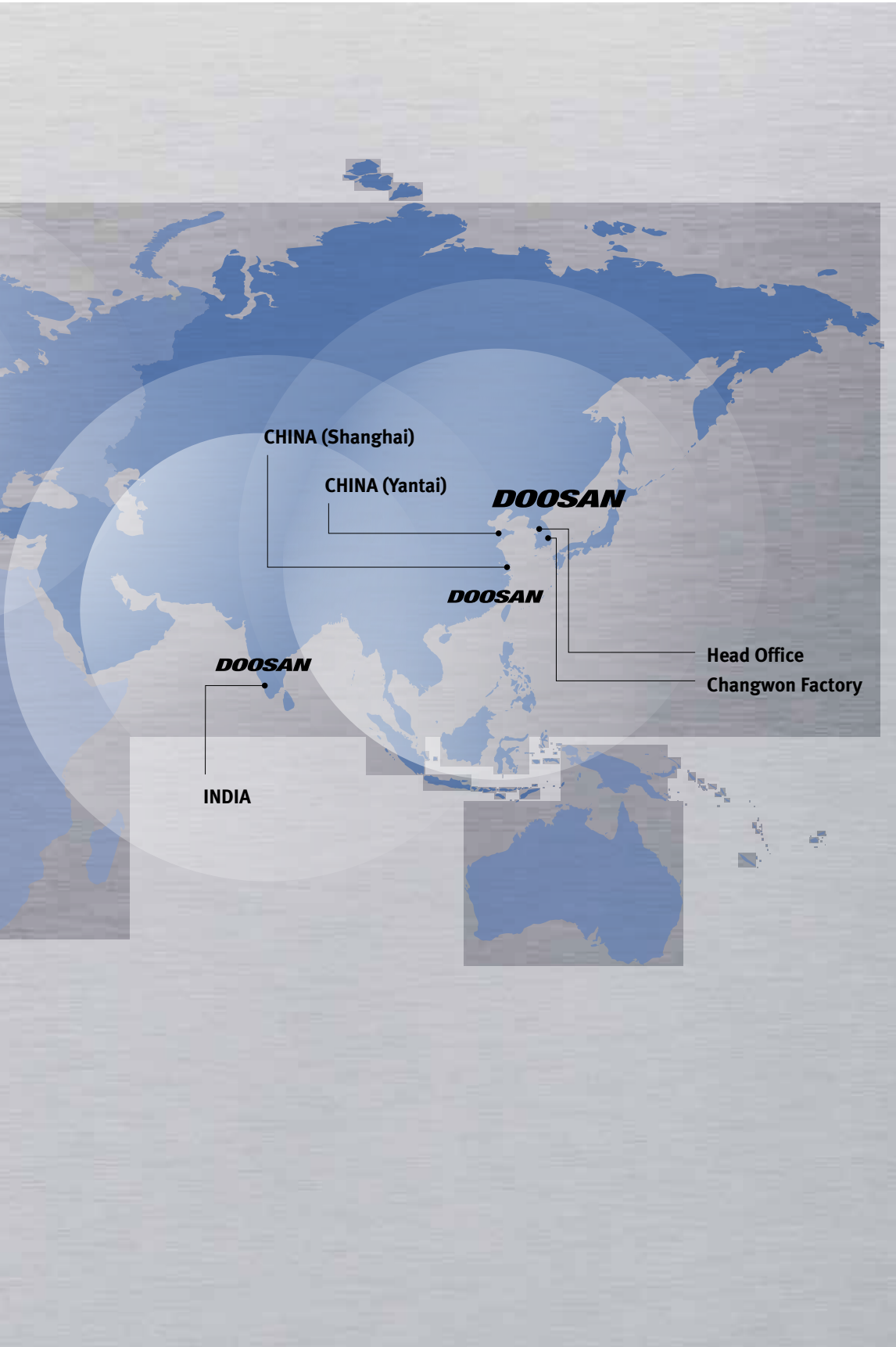

Customer Support Service

We help customers to achieve success by providing a variety of professional services from pre-sales consultancy to post-sales support.

Supplying Parts



- Supplying a wide range of original Doosan spare parts
- Parts repair service

Field Services



- On site service
- Machine installation and testing
- Scheduled preventive maintenance
- Machine repair

Technical Support



- Supports machining methods and technology
- Responds to technical queries
- Provides technical consultancy

Training



- Programming / machine setup and operation
- Electrical and mechanical maintenance
- Applications engineering

Major Specifications

Mynx II series

Description		Unit	Mynx 5400 II	Mynx 5400/50 II	Mynx 6500 II	Mynx 6500/50 II	Mynx 7500 II	Mynx 7500/50 II	Mynx 9500
Max. spindle speed	Direct	r/min	8000 {12000}*	-	8000 {12000}*	-	8000 {12000}*	-	-
	Belt		-	6000 {6000}* {8000}* {6000}*	-	6000 {6000}* {8000}* {6000}*	-	6000 {6000} {8000} {6000}*	-
	Gear		-	{6000}*	-	{6000}*	-	{6000}*	6000
	Built in		-	-	-	-	-	-	{10000}*
Max. spindle power	Direct	kW (Hp)	15 (20.1)/ 11 (14.8) {15.6 (20.9)}*	-	15 (20.1)/ 11 (14.8) {15.6 (20.9)}*	-	15 (20.1)/ 11 (14.8) {15.6 (20.9)}*	-	-
	Belt		-	15 (20.1)/ 11 (14.8) {18.5 (24.8)/ 15 (20.1)}* {15 (20.1)/ 11 (14.8)}*	-	15 (20.1)/ 11 (14.8) {18.5 (24.8)/ 15 (20.1)}* {15 (20.1)/ 11 (14.8)}*	-	18.5 (24.8)/ 15 (20.1) {22 (29.5)/ 18.5 (24.8)}* {15 (20.1)/ 11 (14.8)}*	-
	Gear		-	{30 (40.2)/ 18.5 (24.8)}	-	{30 (40.2)/ 18.5 (24.8)}*	-	{30 (40.2)/ 18.5 (24.8)}*	30 (40.2)/ 18.5 (24.8)
	Built in		-	-	-	-	-	-	{30/25 (40.2/33.5)}*
Max. spindle torque	Direct	N·m (ft·lbs)	286.5 (211.4) {165.5 (122.1)}*	-	286.5 (211.4) {165.5 (122.1)}*	-	286.5 (211.4) {165.5 (122.1)}*	-	-
	Belt		-	286.4 (211.2) {306.9 (226.3)}* {286.4 (211.2)}*	-	286.4 (211.2) {306.9 (226.3)}* {286.4 (211.2)}*	-	306.9 (226.3) {365.5 (269.5)}* {286.4 (211.2)}*	-
	Gear		-	{617.4 (455.6)}	-	{617.4 (455.6)}	-	{617.4 (455.6)}	617.4 (455.6)
	Built in		-	-	-	-	-	-	{420 (310.0)}*
Taper	-	ISO #40	ISO #50	ISO #40	ISO #50	ISO #40	ISO #50	ISO #50	
Travel distance (X / Y / Z)	mm (inch)	1020 / 550 / 530 (40.2 / 21.7 / 20.9)		1270 / 670 / 625 (50.0 / 26.4 / 24.6)		1525 / 770 / 625 (60.0 / 30.3 / 24.6)		2500 / 950 / 850 (98.4 / 37.4 / 33.5)	
Tool storage capa.	ea	30 {40}*	24	30 {40}*	24 {30}*	30 {40}	24 {40}*	30 {40}*	
Table size	mm (inch)	1200 x 540 (47.2 x 21.3)		1400 x 670 (55.1 x 26.4)		1600 x 750 (63.0 x 29.5)		2500 x 950 (98.4 x 37.4)	
Max weight on Table	kg (lb)	1000 (2204.6)		1300 (2866.0)		1500 (3306.9)		3500 (7716.1)	

*{ } Option



Doosan Machine Tools

www.doosanmachinetools.com



Head Office

22FT Tower, 30, Sowol-ro 2-gil, Jung-gu,
Seoul, Korea, 04637

Tel +82-2-6972-0370 / 0350

Fax +82-2-6972-0400

Doosan Machine Tools America

19A Chapin Rd., Pine Brook, NJ 07058, U.S.A.

Tel +1-973-618-2500

Fax +1-973-618-2501

Doosan Machine Tools Europe

Emdener Strasse 24, D-41540 Dormagen,
Germany

Tel +49-2133-5067-100

Fax +49-2133-5067-111

Doosan Machine Tools India

No.82, Jakkuar Village, Yelahanka Hobli,
Bangalore-560064

Tel + 91-80-2205-6900

E-mail india@doosanmt.com

Doosan Machine Tools China

Room 101,201,301, Building 39 Xinzhuang
Highway No.258 Songjiang District, China
Shanghai(201612)

Tel +86 21-5445-1155

Fax +86 21-6405-1472

* For more details, please contact Doosan Machine Tools.

* The specifications and information above-mentioned may be changed without prior notice.

* Doosan Machine Tools Co., Ltd. is a subsidiary of MBK Partners. The trademark **DOOSAN** is used under a licensing agreement with Doosan Corporation, the registered trademark holder.

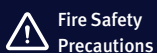

Fire Safety
Precautions

There is a high risk of fire when using non-water-soluble cutting fluids, processing flammable materials, neglecting use coolants and modifying the machine without the consent of the manufacturer. Please check the SAFETY GUIDANCE carefully before using the machine.

ver. EN 200309SU