



SUPER MULTI-TASKING TURNING CENTER

SMX

2100/S/ST/B/SB/STB • **2600/S/ST** • **3100/S/ST/L/LS**



DN SOLUTIONS

SMX SERIES

The SMX series - Our next generation multi-tasking turning centers are high-productivity, high-precision machines that are easy to operate. By integrating the functionalities and capabilities of multiple machines into one system, the SMX series provides users with a multi-tasking machine tool solution that significantly reduces machining time and machining operations. The SMX series also delivers excellent high-precision machining; accuracy is assured by minimizing thermal deformation through the use of thermal compensation sensors and systems. Ergonomic design focused on operator convenience, and on efficient and effective maintenance provides the optimal solution that meets every customer's needs.





* This image contains several options.

HIGHER PRODUCTIVITY THROUGH POWERFUL MULTITASKING FUNCTIONS

- Complex machining capabilities of the left spindle, right spindle, B-axis, milling spindle and lower
- Highly-rigid machine construction using structural analysis design
- Maximized Y-axis stroke through machine's orthogonal design structure
- Maximized productivity achieved through simultaneous machining

ENHANCED PRECISION THROUGH HIGH ACCURACY CONTROL FUNCTIONS

- Minimized thermal deformation of the spindle and feed axis using oil cooler system
- A doption of roller LM guideways with high-rigidity and high precision
- Equipped with 0.0001° B-axis and C-axis accuracy control functions

EASY AND CONVENIENT OPERATION THROUGH AN ERGONOMIC DESIGN

- Front located tool magazine
- Side-to-side movable swiveling Operation panel with adjustable Height(SMX2100 : Swiveling & height adjustment possible)
- Convenient ATC-magazine operation panel

BASIC STRUCTURE

All units are combined in an orthogonal direction to create a highly rigid structure that is intuitive and stable for users, and guarantees stable performance under any processing conditions.

Robust design

FEM (Finite Element Method) analysis results in superior machine stability. All guideways are sealed with a protective covers, preventing high temperature chips and coolant from contacting the guideways, thus maintaining unsurpassed long-term accuracy.

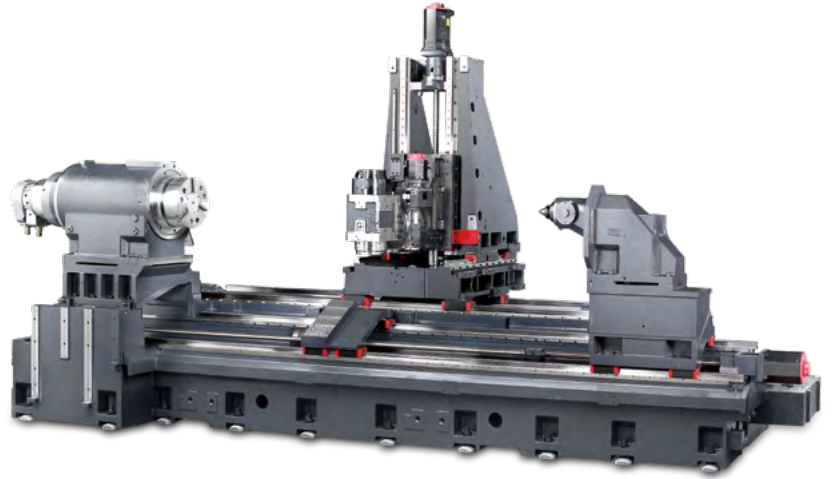
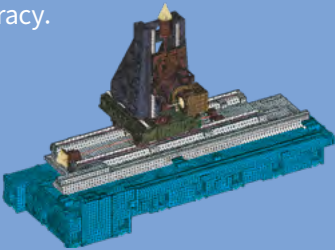

Feed axis

Extended axis travels and improved rapid rates improve machining capacity and deliver excellent productivity. The X, Y and Z-axes move orthogonally to ensure high accuracy and repeatability.

Travel	Unit : mm(inch)			
Model	SMX 2100/S/ ST/B/ST/STB	SMX 2600/S, 3100/S	SMX 3100L/ LS	SMX 2600ST /3100ST
X-axis	630 (24.8)	630 (24.8)	630 (24.8)	695 (27.4)
Y-axis	210 (±105) (8.3 (±5.9))	300 (±150) (11.8 (±5.9))		
Z-axis	1085 (42.7)	1585 (62.4)	2585 (101.8)	1585 (62.4)
A-axis	1097 (43.2) ① 1075 (42.3) ②	1605 ① (63.2) 1562 ② (61.5)	2500 ① ② (98.4)	1538 ① (60.6)
B-axis	240 (±120) deg. (9.4 (±4.7))			
X2-axis	220 (8.7) (model : ST)	-	-	235 (9.3)
Z2-axis	1047 (41.2) (model : ST)	-	-	1540 (60.6)

① Right spindle ② Servo tail stock

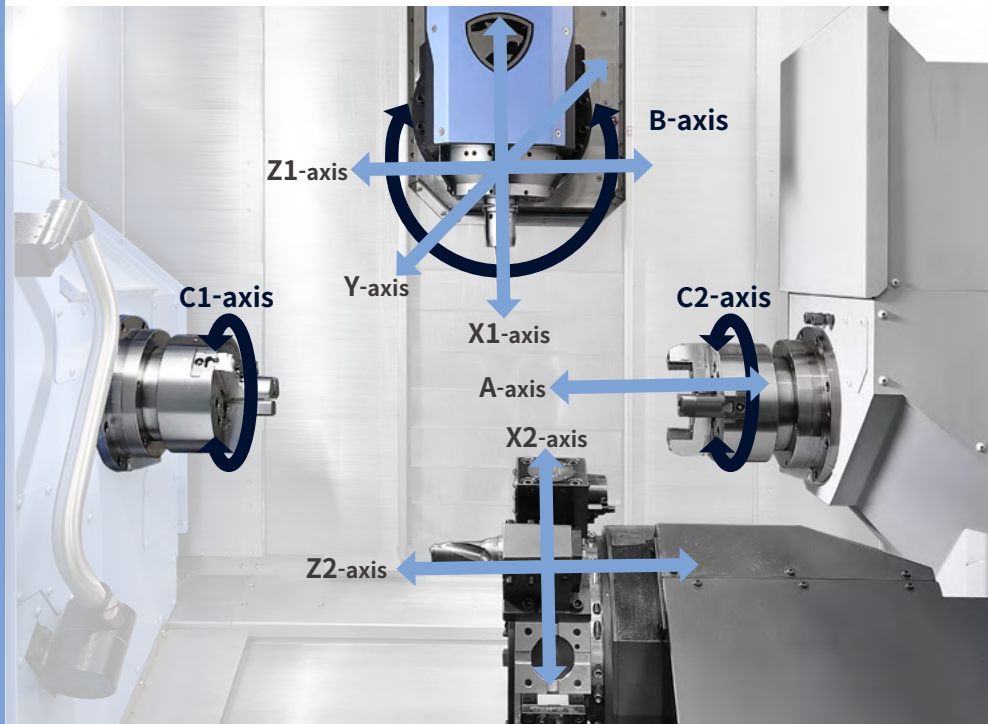

High precision roller type LM guideways

Highly qualified roller type LM guideway realizes fine precision and fast speed, minimizing non-cutting time and re-machining work

Rapid traverse rate	Unit : m/min (ipm)			
Model	SMX 2100/S/ ST/B/ST/STB	SMX 2600/S, 3100/S	SMX 2600ST /3100ST	SMX 3100L/LS
X-axis	48 (1889.8)			
Y-axis	36 (1417.3)			
Z-axis	48 (1889.8)			30 (1181.1)
A-axis	30 ① (1181.1)			20 ① (787.4)
B-axis	40 r/min			
X2-axis	24 (944.9)	-	24 (944.9)	-
Z2-axis	36 (1417.3)	-	36 (1417.3)	-

① Right spindle (Servo tail stock is not applicable)

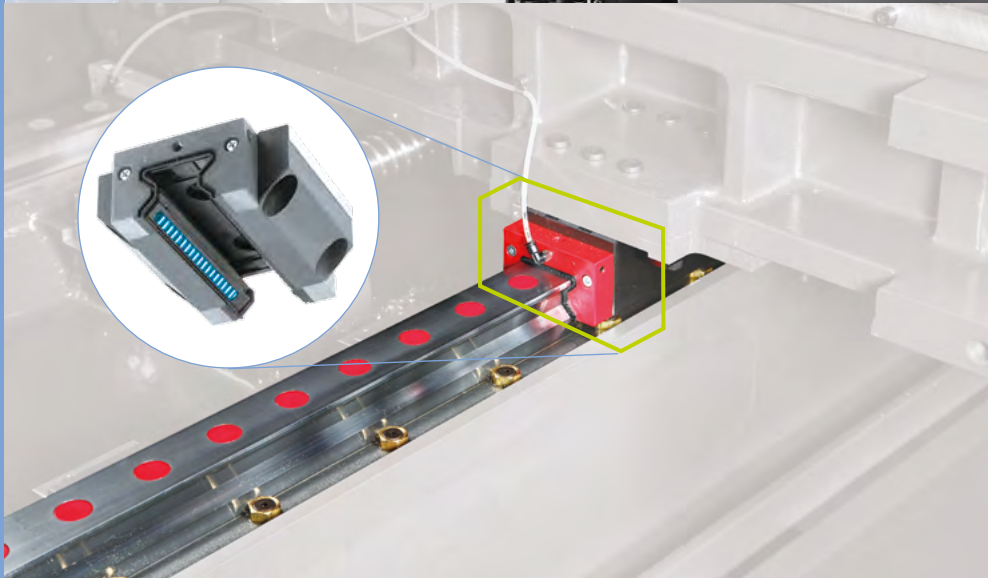

COOLING CONCEPT TO ACHIEVE HIGH ACCURACIES OVER LONG MACHINING RUNS

Machines have been designed and built to minimize thermal displacement and ensure superior accuracies over long machining runs and lengthy periods of operation.

Minimizing thermal deformation by oil cooling

A spindle and ballscrew core cooling system minimizes thermal deformation during long machining runs to achieve high-accuracy parts production.

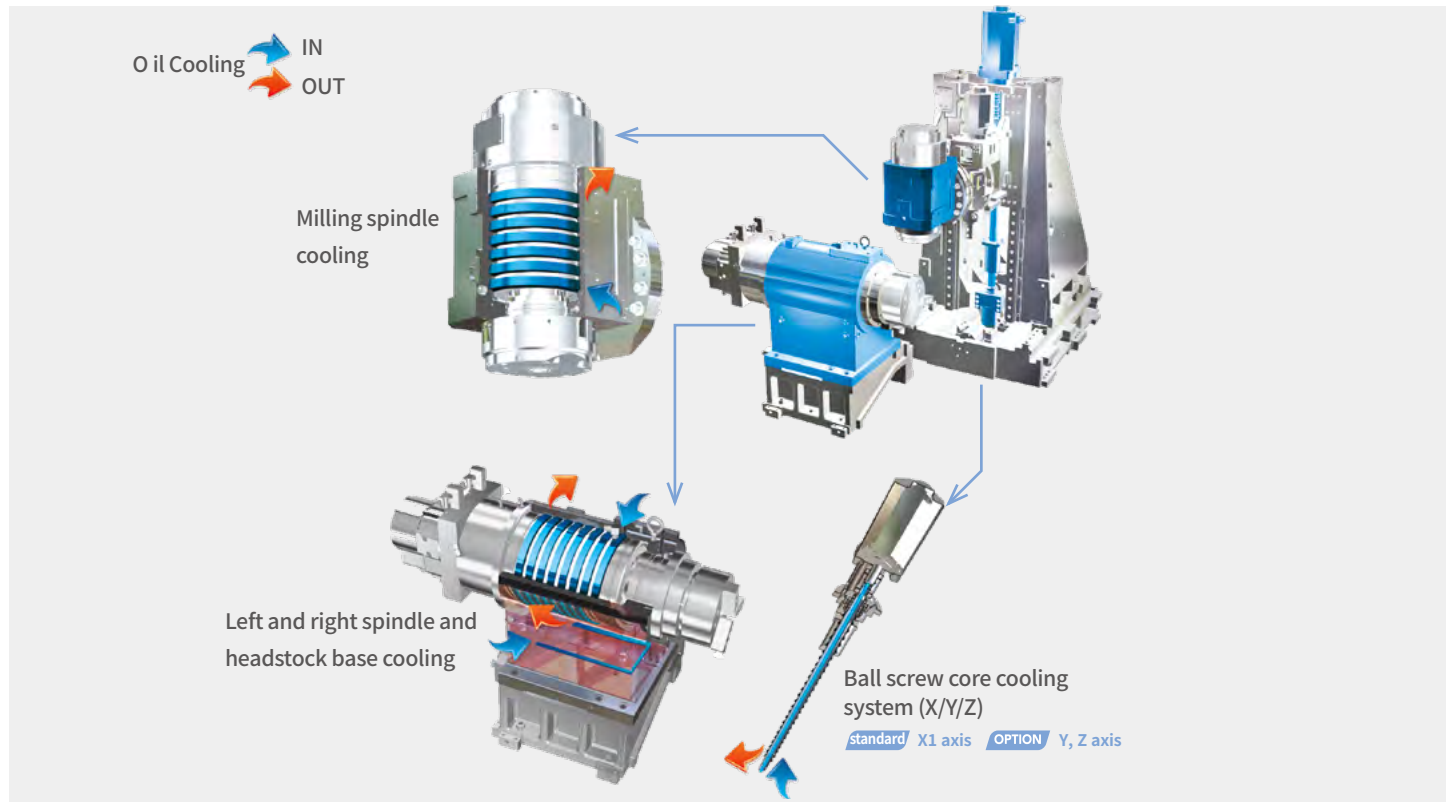

Circularity

By undertaking extensive testing of individual machine elements and analysing the results in detail, the SMX series achieves a high level of precision and reliability that exceeds customer expectations.

Turning (O.D. machining)

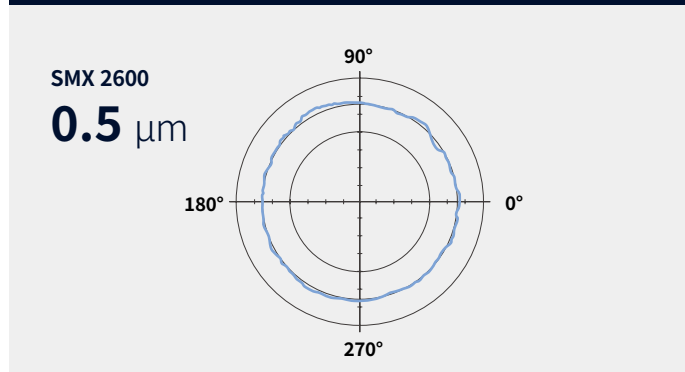

Material	Aluminium
Tool	Diamond tool (Nose radius 0.5 mm (0.02 in.))
Spindle speed	3000 r/min
Feedrate	0.5 mm/rev (0.02 ipr)

Milling (X-Y contouring)

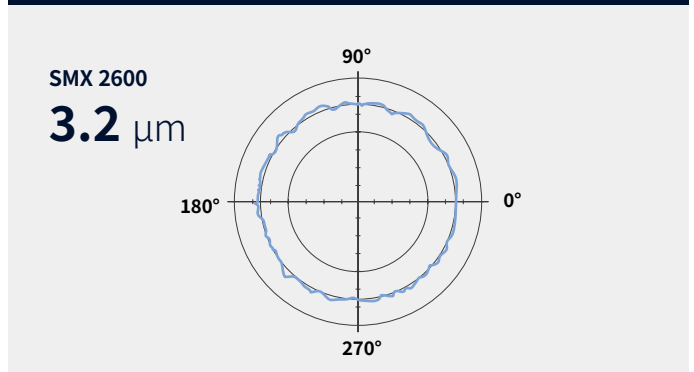

Material	Aluminium
Tool	End mill \varnothing 20 mm (0.787 in.)
Spindle speed	8000 r/min
Feedrate	2500 mm/min (98.4 ipm)

* This test is performed under DN Solutions Machine Tool's test environment.

MACHINING AREA

An increased machining area, as a result of the SMX machines' orthogonal structure, and an extended turning diameter capability, enables the machining of large workpieces.

Maximized X-axis, Y-axis machining area through orthogonal structure design

Wide X-axis, Y-axis enables machining of parts of various sizes/shapes, making machining programming and set-up easier.

X-axis machining area

SMX 2100/B
630 mm 24.8 inch

SMX 2600/3100
630 mm 24.8 inch

SMX 2600ST/3100ST
695 mm 27.4 inch

Y-axis machining area

SMX 2100/B
210 mm
8.3 inch

SMX 2600/3100
300 mm
11.8 inch

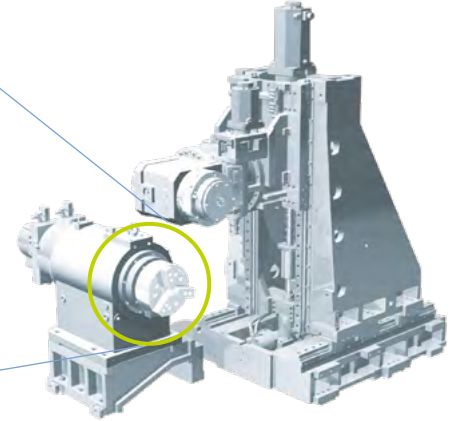
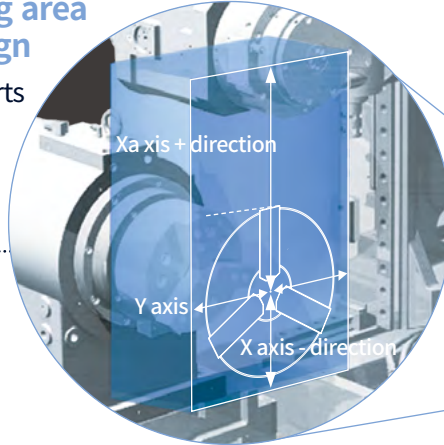

Y-axis : ± 105 mm(SMX2100/B), ± 150 mm(SMX2600/3100)
X-axis +direction : 525mm(SMX2100/B), 505mm(SMX2600/3100), 570mm(SMX2600ST/3100ST)
X-axis -direction : 105mm(SMX2100/B), 125mm(SMX2600/3100)

Extended machining area

Extended area enable various machining of large and long materials, and make it easy for users to access inside for set-up.

(A) Max. machining diameter

SMX 2100/B
600 mm
23.6 inch

SMX 2600/3100
660 mm
26.0 inch

(B)Max. machining length

SMX 2100/B
1040 mm
40.9 inch

SMX 2600/3100
1540 mm
60.6 inch

SMX 3100L
2540 mm
100.0 inch

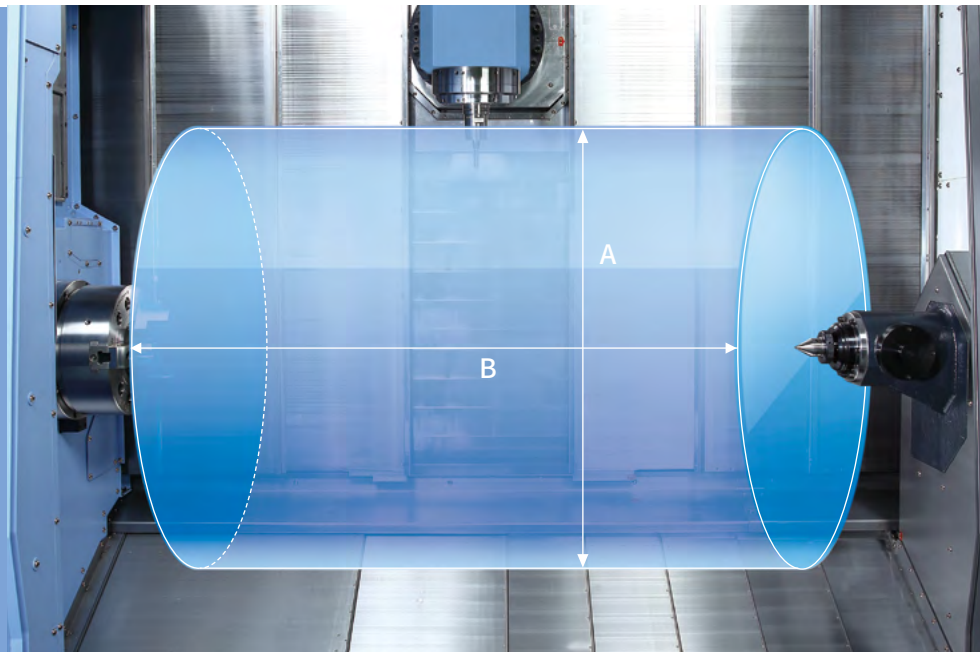

Large bar working diameter

SMX 2100
65 mm 2.6 inch

SMX 2100B / 2600
81 mm 3.2 inch

SMX 3100
102 mm 4.0 inch

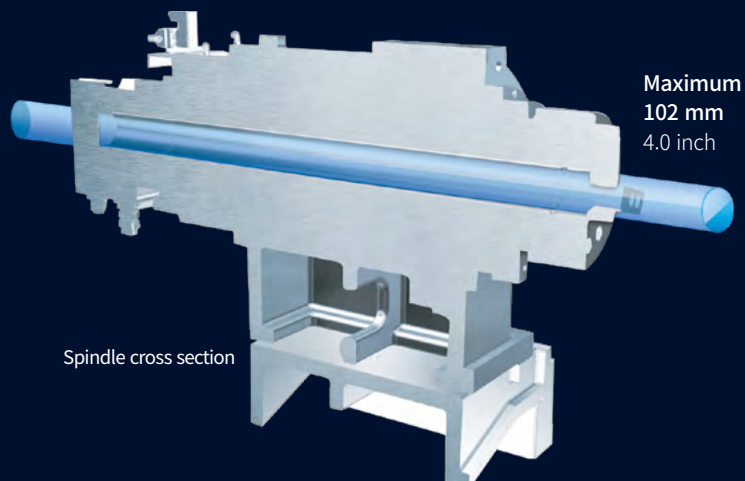

Spindle cross section

Maximum
102 mm
4.0 inch

CUTTING PERFORMANCE

Powerful and fast machining capability across turning, milling, drilling, tapping and other multi-tasking operations ensures higher productivity and efficiency.

Powerful machining

O.D. cutting (SMX 3100)

Spindle speed r/min	Cutting speed m/min (ipm)	Feedrate mm/rev	Radial cutting depth mm (inch)	Material removal rate cm ³ /min (inch ³ /min)
253	210 (8267.7)	0.55 (0.0)	8.5 (0.3)	1405 (85.7)

U-drill (milling)

Tool mm (inch)	Spindle speed r/min	Feedrate mm/min (ipm)	Material removal rate cm ³ /min (inch ³ /min)
Ø63 (2.5)	1010	131 (5.2)	409 (25.0)

Face milling

Tool mm (inch)	Milling spindle speed r/min	Radial cutting depth mm (inch)	Feedrate mm/min (ipm)	Material removal rate cm ³ /min (inch ³ /min)
Ø80 (3.1)	1100	5 (0.2)	1117 (44.0)	357 (21.8)

End milling

Tool mm (inch)	Milling spindle speed r/min	Radial cutting depth mm (inch)	Feedrate mm/min (ipm)	Material removal rate cm ³ /min (inch ³ /min)
Ø25 (1.0)	382	25 (1.0)	200 (7.9)	125 (7.6)

Tapping

Tool mm (inch)	Milling spindle speed r/min	Feedrate mm/min (ipm)
M30 x P3.5 (M1.2 x P0.1)	212	742 (29.2)

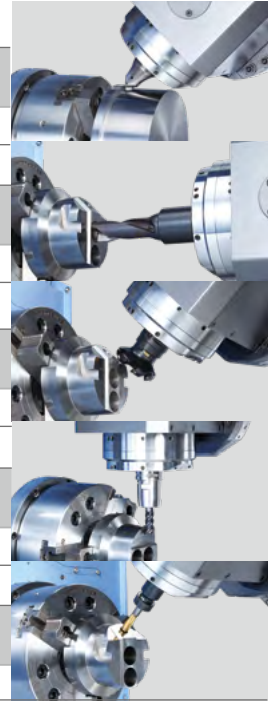

* The results above are provided as examples only. Different cutting and environmental conditions may give different results.

Higher productivity through multi-tasking operation

Faster machining times compared to working with many conventional machines provides superior productivity and machining capability.

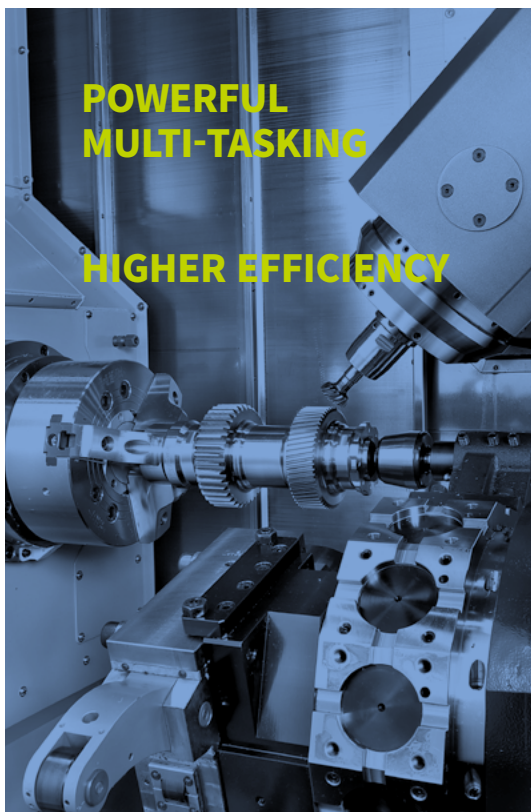

Reduced production lead time by

75 %

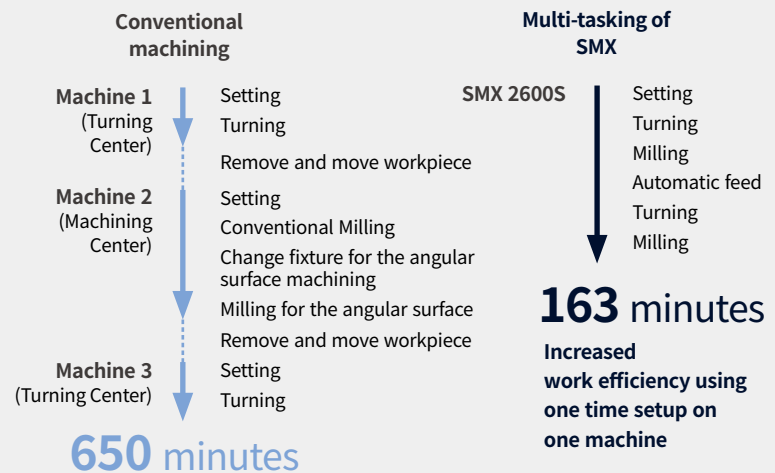

SPINDLE

Perfect combination of three high-performance spindles to ensure machining stability operating under various cutting conditions.

Milling spindle

12000 r/min

SMX 2100/B SMX 2600/3100
22 kW **26 kW**

Tool shank of milling spindle

CAPTO C6 {HSK-T63^{OPTION}}

Left spindle

SMX 2100
8 inch

SMX 2100B/2600
10 inch

SMX 3100
12 inch

Right spindle(S/ST/LS)

SMX 2100/B
8 inch

SMX 2600/3100
10 inch

Perfect combination of rotating spindles

Both left and right spindles are capable of high-accuracy C-axis operation and, with the milling spindle, can perform various machining functions like turning, milling and synchronized cutting in a single set up.

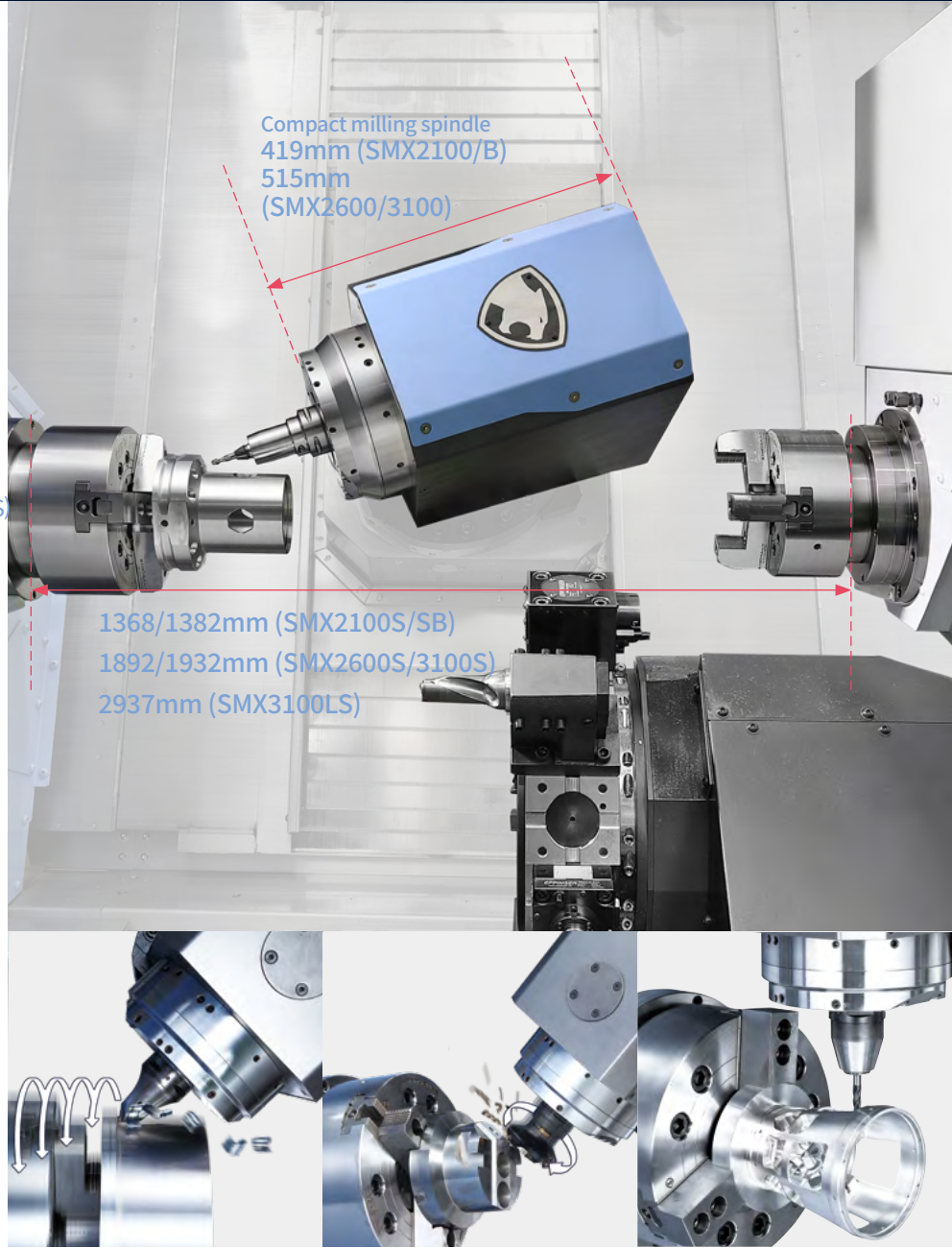

Model	Spindle	Standard Chuck inch	Spindle speed r/min	Power kW (Hp)	Torque N · m (ft·lbs)	Condition
SMX 2100 series	Left Spindle	8	5000	22/22/18.5/15 (29.5/29.5/24.8/20.1)	467 (344.6)	S3 15%/25%/30min/cont.
SMX 2100B series		10	4000	22/22/22/15 (29.5/29.5/29.5/20.1)	512 (377.9)	S3 15%/25%/15min/cont.
SMX 2600 series		10	4000	30/22 (34.9 / 29.5)	724 (516.6)	S3 25%/cont.
SMX 3100 series		12	3000	30/25 (40.2 / 33.5)	1204 (887.8)	30min/cont.
SMX 2100 S/ST/SB/STB	Right Spindle	8	5000	22/18.5/15 (29.5/24.8/20.1)	467	S3 15%/30min/cont.
SMX 2600S/ST, 3100S/LS/ST		10	4000	30/22 (34.9 / 29.5)	724 (516.6)	S3 25%/cont.

Torque	Spindle	Standard Chuck inch	Spindle speed r/min	Power kW (Hp)	Torque N · m (ft·lbs)	Condition
SMX 2100/2100B series	Milling Spindle	CAPTO C6	12000	22/22/18.5/15 (29.5/29.5/24.8/20.1)	84.3 (62.2)	S3 15%/25%/30min/cont.
SMX 2600/3100 series				26/18.5/15 (34.9 / 24.8 / 20.1)	124 (91.5)	2.5min/10min/cont.

SPINDLE | TAILSTOCK

High precision control of spindle axes (C & B-axis)

Machining operation is mainly done by the Left spindle and the Milling spindle. The C-axis of the left spindle and the B-axis of the milling spindle, with Y-axis control, facilitates multi-tasking operations i.e. drilling, tapping and end milling at any angle. It also enables the machining of precise angles and sculpted contours via 5-axis simultaneous machining.

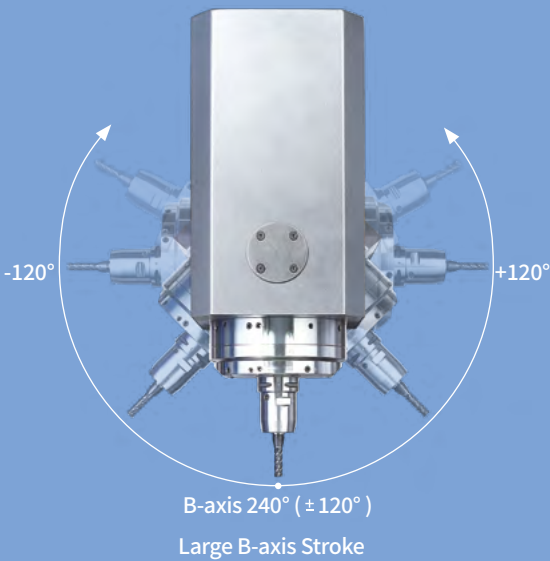

Left spindle



C-axis positioning control

To enhance C-axis positional accuracy of the left spindle, a positioning compensation sensor has been used. The left spindle can have C-axis positioning control every 0.0001° increment over 360°.

B-axis positioning control - precise continuous indexing

High-accuracy B-axis indexing (every 0.0001° over $\pm 120^\circ$) delivers outstanding positioning accuracy and enables a range of machining operations to be undertaken - from horizontal front face machining to angular machining.

Braking index at a random angle

Within its $\pm 120^\circ$ range, the B-axis can be indexed and braked precisely at a random angle.



Swivelling and indexing of the B-axis is achieved by a servo motor and a roller gear cam operating with high-rigidity and high-precision.

Tailstock

Easier and faster set-up of the tailstock using M-code programming (control servo motor and ballscrew).

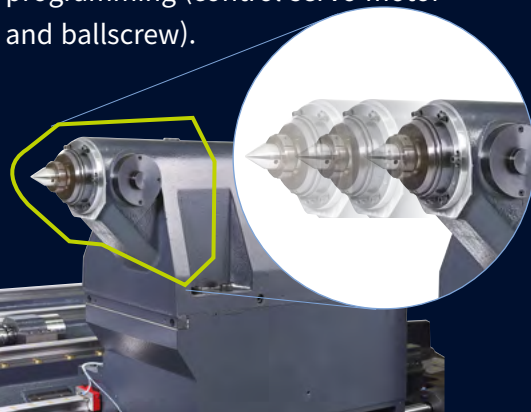

Servo-driven tailstock

The servo-driven tailstock makes set-ups faster and easier to complete. The operator inputs the proper M-code information into the control and the tailstock moves to its correct position automatically, by linear motion control of the servo motor and ballscrew. No manual adjustments are required.

Model	Tail stock travel mm (inch)	Max. quill thrust force kN	Tail stock center
SMX 2100/B	1075 (42.3)	7	Built-in type dead center, MT#4
SMX 2600/3100	1562 (61.5)	10	Built-in type dead center, MT#5
SMX 3100L	2500 (98.4)	15	

AUTOMATIC TOOL CHANGER

The servo-driven ATC and servo tool magazine ensures fast and reliable tool indexing.

Tool storage

40{80/120^{OPTION}} tools

Max. tool length (from gauge line)

SMX 2100/B

300 mm
11.8 inch

SMX 2600/3100

450 mm
17.7 inch

Max. tool weight

12 kg
26.5 lb

Max. tool moment

9.8 N·m
7.2 ft-lbs

Max. tool diameter (continuous)

90 mm
3.5 inch

Max. tool diameter (adjacent pots are empty)

130 mm

5.1 inch
Enlarged touchscreen panel is available as an option

7{10.4^{OPTION}} inch

Servo-driven ATC and tool magazine

The tool magazine capacity can be increased to 120 tools. Tools are selected by the fixed address method that helps reduce changeover times.

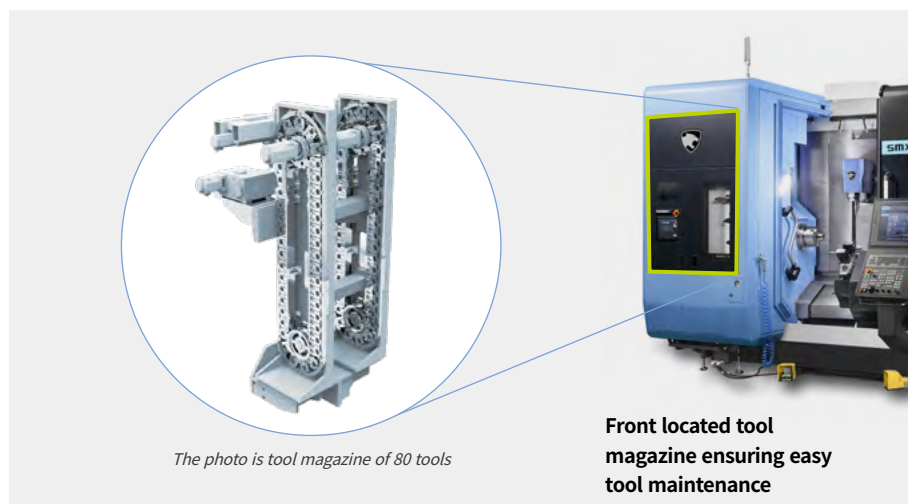

ATC operation panel

The status of the ATC and the tool magazine can be viewed on a separate touchscreen. The touchscreen is used to operate the ATC, the tool magazine and the tool pot carrier.



ATC magazine information display

The operational status of the ATC magazine, which is difficult to check from outside, can be seen at a glance.

Convenient touchscreen operation

Available buttons are activated according to current and next step operations. In this way complex manual operations are undertaken logically and easily.

Tool magazine monitoring

Tool magazine status can be monitored in real time by a CCTV installed inside the magazine.

** Only available with 10.4 inch ATC operation panel*

ADDITIONAL TOOL MAGAZINE

As an option, just for SMX 3100L/LS, a long boring bar magazine is available for machining long parts (i.e. tubes, valves etc.).

Max. tool size

Ø60 x L600 mm
Ø 2.4 x L 23.6 inch

Max. weight

15 kg
33.1 lb

Max. tool size

Ø30 x L800 mm ②
Ø 2.4 x L 31.5 inch

Max. weight

15 kg
33.1 lb

Tool magazine for long boring bar OPTION SMX 3100L / LS

SMX 3100L/LS can be equipped with a long boring bar magazine as an option.



Tool storage

3 tools ①

SMX 3100L/LS can accommodate workpieces up to 2540mm between centers. The machine can process long tubes such as landing gear axles requiring a center bore. Because the automatic Tool changer on this model cannot handle a long boring bar, the separate tool magazine, just for these tools, has 3 tool stations for tools up to 600mm.

- ① Customers can select a tool storage capacity of 2+1 tools instead of 3 tools. The 2+1 storage means 2 tools of Ø60 x L600 mm or Ø30 x L800 mm and 1 large diameter tool, Ø190 x L200 mm, can be mounted in the long boring bar magazine.
- ② A Ø30 x L800 mm sized tool is not classed as a long boring bar but a Gun drill. We do not recommend long boring bar sizes of Ø30 x L800 mm.

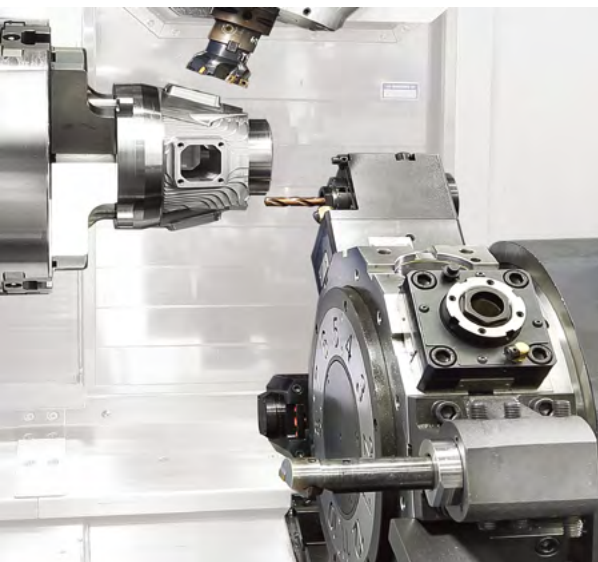

Rigid servo-driven lower turret

(SMX 2100ST/STB/ 2600ST/3100ST)

Turret rotation, acceleration/ deceleration and the large diameter curvic coupling are all controlled by a high-torque servo-motor. Unclamping and rotation are virtually simultaneous. Fast indexing helps keeps cycle times short.

Number of tool stations

SMX 2100ST/STB

OPTION

12 ea, **24**st. Indexing

SMX 2600ST/3100ST

12 ea

Tool holder type OPTION

SMX 2100ST/STB

BMT 55P

SMX 2600ST/3100ST

BMT 65P

Max. rotary tool speed

5000 r/min OPTION

10000 r/min OPTION

*10000 r/min : available on only SMX2100ST/STB

Various applications for the lower turret

Case1) OPTION Steady rest on lower turret

Case2) OPTION Tailstock on lower turret application for long part machining

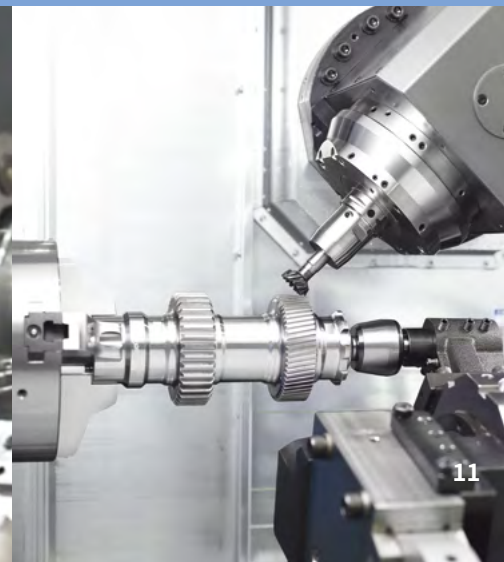
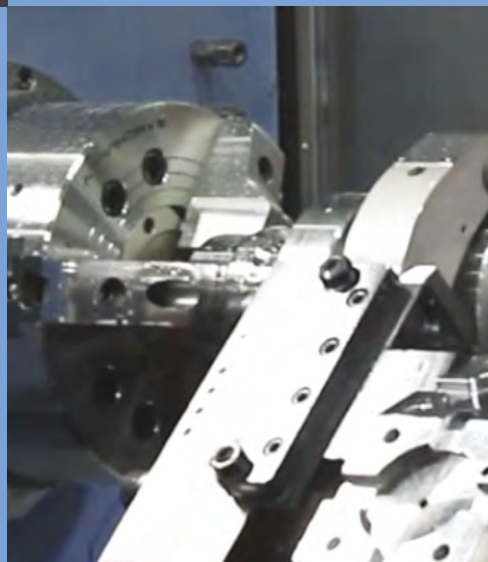

APPLICATION PERFORMANCE

Multi-tasking, which is performing more than one duty at a time, can deliver up to a 40% increase in productivity and can have a positive impact on your company's bottom line.

Benefits of multi-tasking

Using a single set up, one machine is capable of performing all machining processes that generally require two, three or even more machines to complete. By minimizing time and labor, the process cost is reduced and lead times are shortened by up to 75%. This provides a significant advantage when undertaking high mix : low volume manufacturing.

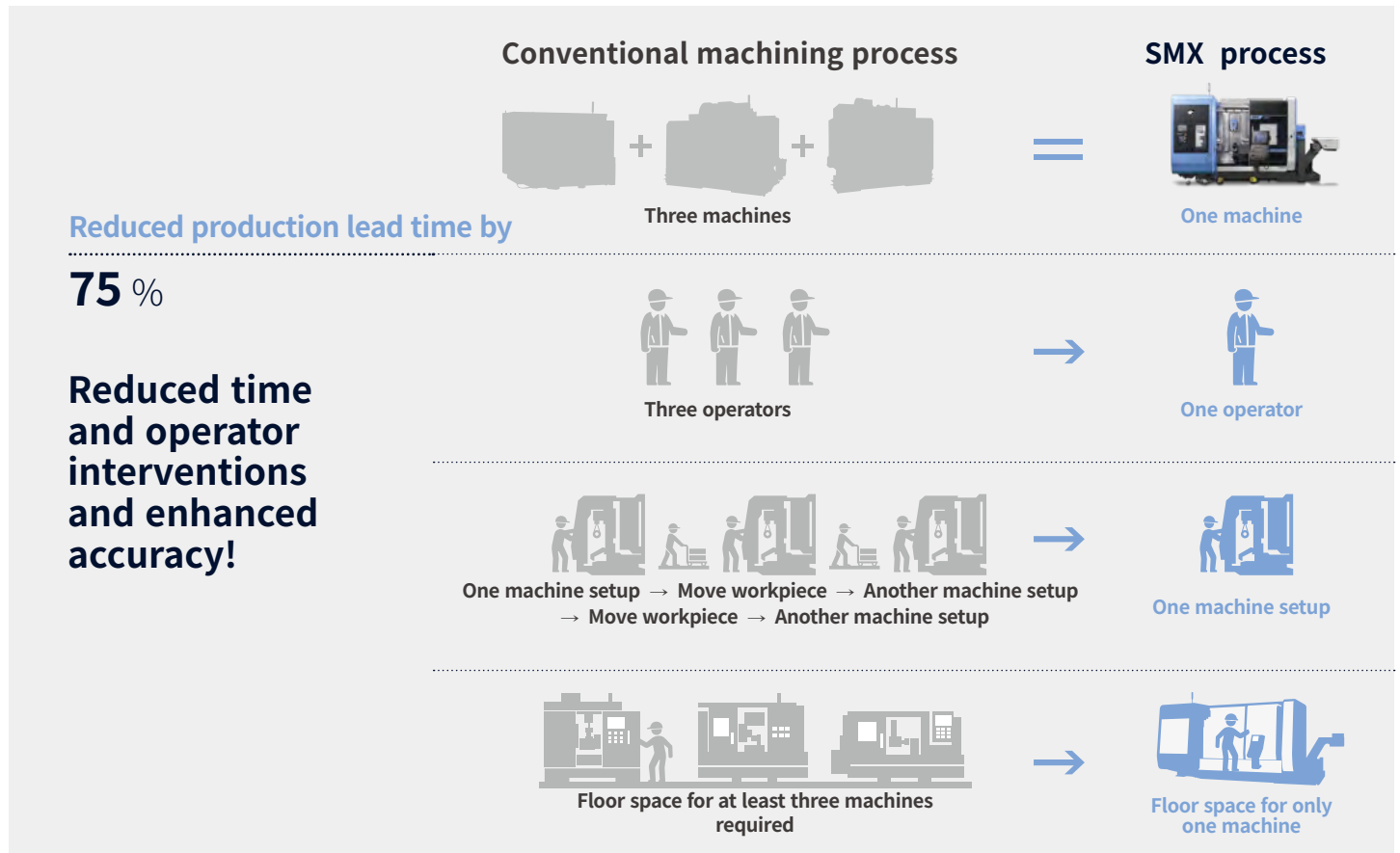

Providing complex 5-axis machining capabilities (Standard with FANUC 31i-5 control)

Simultaneous 5-axis machining functions such as TCP* are built-in, making the machining of complex shapes (i.e. automotive engine impellers or aero-engine blades), much easier and faster to produce.

Smooth tool center point control

- Facilitating the high precision machining of a surface by automatic control of the tool path
- Reducing the time required for setups and for completion of the machining process

The diagram shows a tool tip moving along a curved surface. A red line represents the 'Real tool move' which follows the curvature of the surface. A blue line represents the 'Program' path, which is a straight line. The tool center point (TCP) is marked with a red dot. A note indicates '* TCP : Tool center point'.

Cutting point command OPTION

- Increasing productivity by automatically making all necessary compensations when using various tool tips without having to change the machining program
- Performing effective tool correction

The diagram shows three types of end mills: a Ball-end mill, a Radius-end mill, and a Square-end mill. Each mill is shown cutting a surface. A blue line indicates the 'Cutting point (programmed)' for each mill, showing how the cutting point is adjusted for different tool geometries.

Various applications

Just one machine! The SMX series can satisfy all your machining requirements. Investing in SMX machine seriously boosts your production capabilities and dramatically improves your performance.

Turning

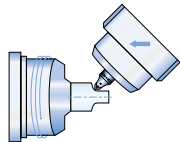

O.D. cutting

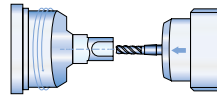

U-Drilling

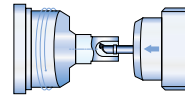

I.D. cutting

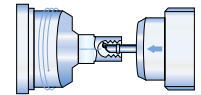

I.D. threading

Milling

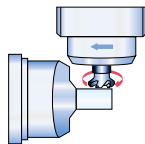

O.D. milling

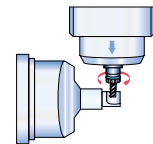

O.D. hole machining

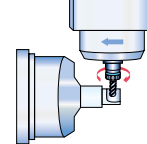

Ball-end milling

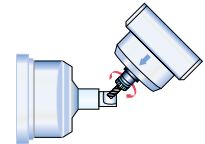

Angular machining

Right spindle

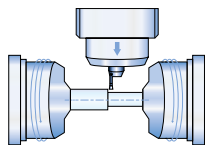

Parting off

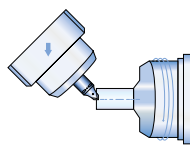

Face cutting

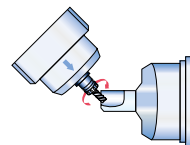

Angular machining

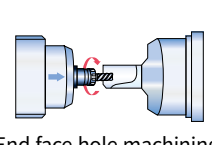

End face hole machining and tapping

Typical applications - 1

A wide range of applications requiring high-performance machining

The sophisticated machining capabilities of SMX machines enable a wide range of applications, across various industries, to be machined to high precision. Specific industries include -: aerospace, energy, shipbuilding, medical, etc.



Drill bits

Industry | Energy
Size | D165 X D175
Material | Stainless steel
Tools | 15



Shaft

Industry | Energy
Size | D150 X L350
Material | Aluminum
Tools | 14



Die roller

Industry | Medical
Size | D185 X L330
Material | Aluminum
Tools | 9

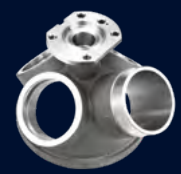

Valve

Industry | General
Size | D300 X L450
Material | Stainless steel
Tools | 6

Typical applications - 2

A wide range of applications requiring high-precision machining

Stable control technology and excellent levels of accuracy enable delicate and detailed workpieces to be machined to high precision.



Housing

Industry | General
Size | D150 X L300
Material | Aluminum
Tools | 6



Impeller

Industry | Aerospace
Size | D120 X L80
Material | Aluminum
Tools | 6

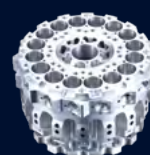

Barrel

Industry | Electronics
Size | D70 X L50
Material | Aluminum
Tools | 50



Bucket Blade

Industry | Energy
Size | 85t x D120 x L600
Material | Stainless steel
Tools | 8

ERGONOMIC DESIGN

Ease-of-use and operator convenience - all part of the machines' ergonomic design.

Ease of machine setup

By laying out the operation panel and tool magazine in a user-friendly way, tooling and workpiece setup becomes more efficient.

Award

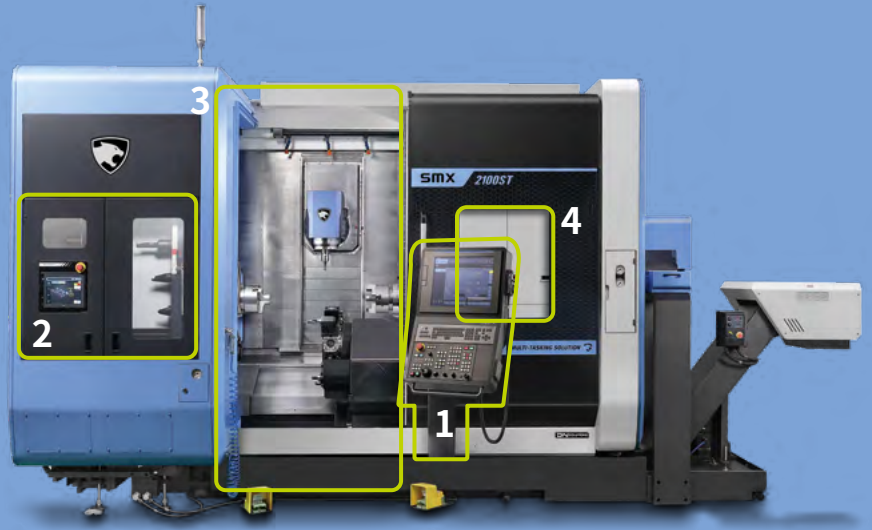

1 Operation panel with side-to-side movement, swivel action and adjustable height setting

Model	Swivel angel adjustment	Height adjustment	Left/Right movement
SMX2100/2100B	0~100°	0~150mm (0~5.9inch)	panel stand rotating (50°)
SMX2600/3100	0~100°	0~190mm (0~7.5inch)	1350mm (53.1inch)



2 Convenient front located tool magazine layout, ATC operation panel

Easy tool loading, managing and monitoring with touch screen.

3 Low-height bed cover structure for easy internal access

Fast and convenient setup and maintenance through improved ergonomic accessibility.

4 Extended front window

Enables the operator to easily monitor the machining process.

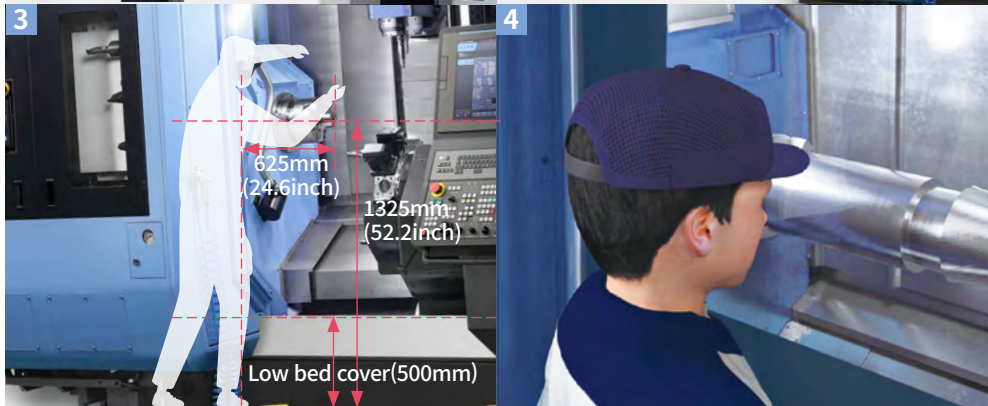

Safety design to reduce collision-caused damage

Machine airbag function

The machine airbag minimizes damage in the event of a machine collision. Sudden changes in axis loads etc., are detected and will trigger the airbag's deployment.

The principle behind the machine airbag function

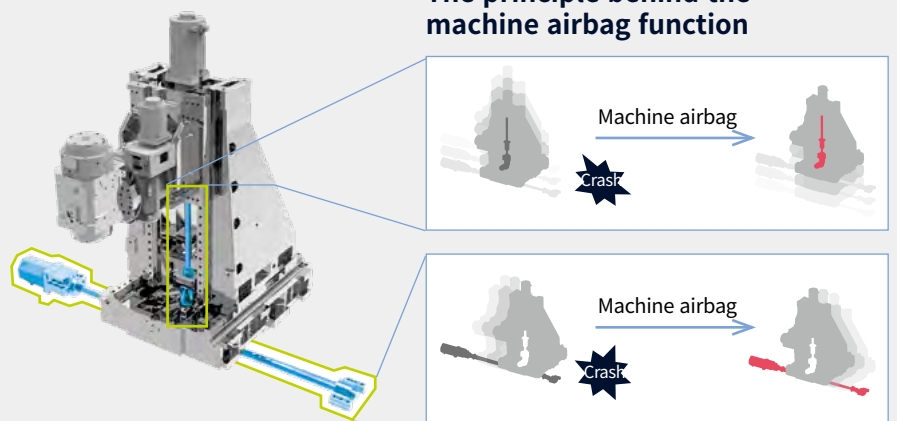

CUSTOMIZED USER-FRIENDLY FLEXIBLE OPERATION SOLUTIONS

CUFOS is a PC based control system created by DN Solutions. equipped with intuitive user-friendly functions such as a smart phone screen and easy customization, CUFOS helps to improve operational efficiency and performance for the user.

CUFOS FEATURES

19 INCH TOUCHSCREEN

- Program memory : 2GB (40GB OPTION)
 - App-based Interface like smart phone, tablet PC

EASY PROGRAMMING

- Sketch cycle : Gear skiving, Gear hobbing, Polygon turning (continuously being added...)
- SSD data server : Program file sharing/ managing (CF card/USB/External PC)

EASY SET-UP/OPERATION

- Tool management for SMX
- CPS(collison protection system)
- Manual viewer
- File manager & PDF viewer

EASY MAINTENANCE

- Status monitor
- Alarm guidance
- Maintenance manager



CUFOS

for SMX ser.

SKETCH CYCLE

Easy and quick, but powerful programming for complex machining

Sketch cycle is easy-to-use conversational programming software that make a support to code complex shapes and machining processes such as gear skiving, hobbing and polygon turning.



Advantages

- Easy to use even for beginners with conversational programming by advising workpiece shapes, tool information and machining conditions
- Expensive CAM software is not required
- Reduce coding time by up to 70% while minimizing trial and errors
- Enable to utilize the recent high productivity processing program such as gear skiving

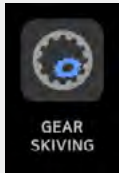

Gear skiving

Gear skiving is carried out in 5 axis machines for more flexible and productive gear machining. The complete component can be finished in one machine, which shorten productiontime and reduce handling and logistics cost.

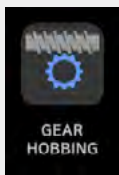
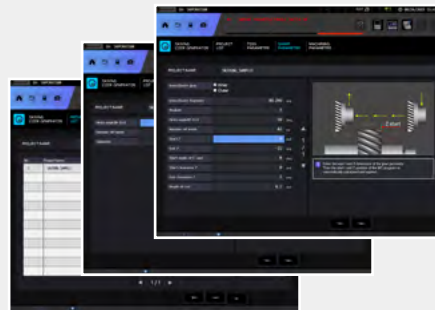

Gear hobbing

Gear hobbing make it easy to proceed gear machining with general turning centers. Gear machining programs can be created by the simple conversational programming so program coding and set-up time can be saved dramatically.

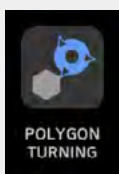
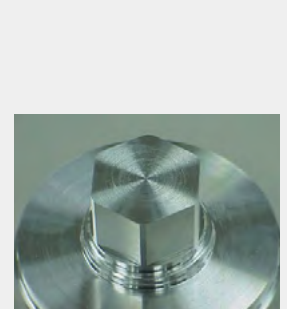
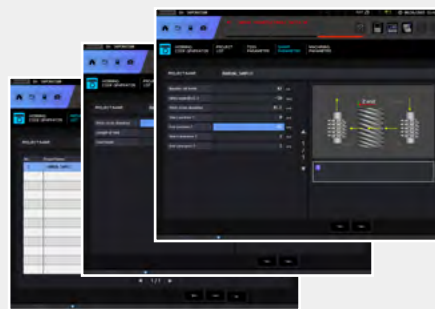

Polygon turning

Polygon turning is a machining process which allows noncircular forms(polygons) to be machine turned without interrupting the rotation of workpieces. It allows rapid production and clean machining of advanced geometries.

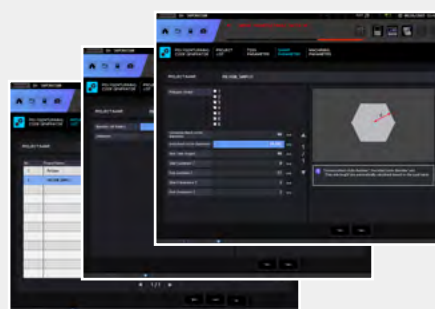

EASY SET-UP | OPERATION

Tool management, collision protection between machine unit/ workpiece/tooling and various user guidance provide higher productivity and user-convenience.



Tool management

DN Solutions EZ work tool management



Includes a summary monitoring screen and gives the operator easy access to DN Solutions's own tool management system which provides comprehensive real time data on each tool, such as remaining tool life and status of tool groups.



CPS (Collision protection system)

A function to prevent real-time collision between the tool and equipment / machine elements inside the working area.

Use the setup manager with the CPS app to build up the machine model, and add tool, workpiece and workholding equipment details.

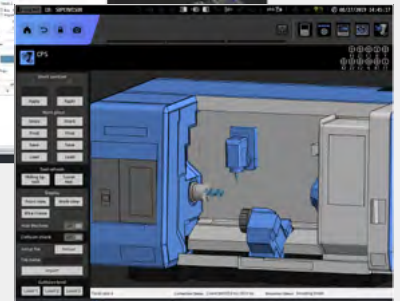
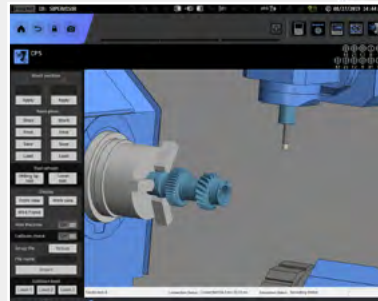

File Manager & PDF viewer

Ability to transfer various type of files including CF cards, USB memory, external PCs and memory inside CUFOS, NC programs between NC memory.

PDF drawings can be directly open on the screen via PDF viewer



EASY MAINTENANCE

Keeping a machine in best condition through status monitoring, alarm guidance and maintenance manager functions.

CUFOS: STANDARD | OPTIONAL SPECS

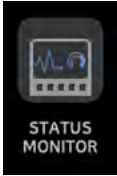

Status monitoring

Monitoring various information such as spindle, milling spindle, feed axis, cycle time, program/tool no. on one screen.



Alarm guidance

Presenting an operator alarm's causes and troubleshooting guides and sending an email when the alarm last for a long time.

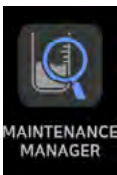
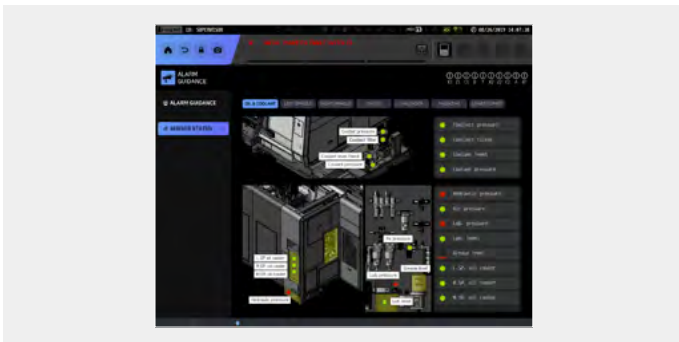

Maintenance manager

Monitors the status of machine and control elements, and confirms the alarm condition and maintenance schedule for preventative maintenance.

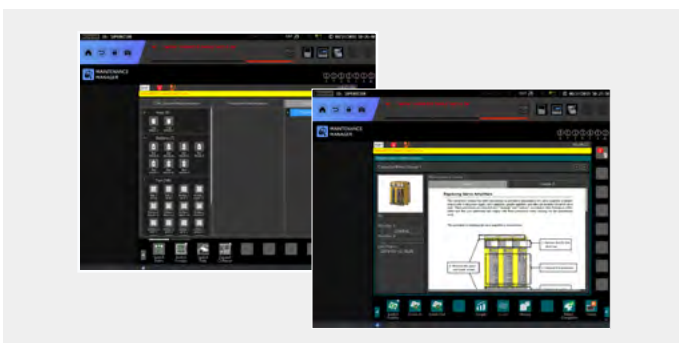

A diverse range of functions and apps are available to meet your needs.

Description	Features	PUMA SMX series
Hardware	Display Unit	19" Color LCD Screen ●
	Main RAM Memory	4GB ●
	Program Storage Memory	5GB ●
		20GB ○
		40GB ○
		2 point-touch panel port ●
	Windows 7 operating system ●	
Applications	DN Solutions Tool Management ○	
	CPS(Collision Protection System) ○	
	SSD Data server application ○	
	Set and Inspection Application(Renishaw) ○	
	Manager's Message Notification application ●	
	FTP Server service ●	
	Smart key access control application ○	
	Memo Application ●	
	Machine status Monitor application ●	
	Alarm guidance application ●	
	Sketch Cycle ○	
	BLUM Contour Scan(BLUM) ○	
	Alarm Notification via email ●	
iHMI Basic Application	Manual viewer application ●	
	Calendar application ●	
	Browser application ●	
	Periodic Maintenance Application ●	
	Data Logger application ●	
	Servo viewer application ●	

● Standard ○ Optional

FANUC 31i/32i PLUS

FANUC 31i/32i PLUS maximizes customer productivity and convenience.

15" Touch screen + New OP

DN Solutions Fanuc 31iB/B5 Plus' operation panel enhances operating convenience by incorporating common-design buttons and layout. It features a Qwerty keyboard for fast and easy data input and operation.



iHMI touchscreen

iHMI provides an intuitive interface that uses a touchscreen for quick and easy operation.

Range of applications

Providing various applications related to planning, machining, improvement and utility, for customer convenience.

Fanuc 31i/32i Plus

- 15-inch color display
- Intuitive and user-friendly design

USB and PCMCIA card QWERTY keyboard

- EZ-Guide i standard
- Ergonomic operator panel
- 4MB Memory
- Hot keys
- Enhance AICC BLOCK
- Touch pen provided as standard



NUMERIC CONTROL SPECIFICATIONS

FANUC

Description	Item	Specifications	SMX2100(L), 2600, 3100(L)	SMX2100(L)S, 2600S, 3100(L)S	SMX2100(L)ST, 2600ST, 3100ST	SMX2100(L), 2600, 3100(L)	SMX2100(L)S, 2600S, 3100(L)S	SMX2100(L)ST, 2600ST, 3100ST	
			Fanuc 31i Plus	Fanuc 31i Plus	Fanuc 31i Plus	Fanuc 31i-5 Plus	Fanuc 31i-5 Plus	Fanuc 31i-5 Plus	
Controlled axis	Controlled axes	Note *1) {Z2} could be supplied as Servo Steady Rest option except for T/ST type.	7 (X, Z, C, B, Y, A, {Z2})	8 (X, Z, C1, B, Y, C2, A, {Z2})	9 (X1, Z1, C1, B, Y, X2, Z2, C2, A)	7 (X, Z, C, B, Y, A, {Z2})	8 (X, Z, C1, B, Y, C2, A, {Z2})	9 (X1, Z1, C1, B, Y, X2, Z2, C2, A)	
	Simultaneously controlled axes		4 axes(Upper X, Z, C, Y) + 1 axes(Lower {Z2})	4 axes(Upper X, Z, C1, Y) + 3 axes(Lower {Z2}, C2, A)	4 axes(Upper X1, Z1, C1, Y) + 4 axes(Lower X2, Z2, C2, A)	5 axes(Upper X, Z, C, B, Y) + 1 axes(Lower {Z2})	5 axes(Upper X, Z, C1, B, Y) + 3 axes(Lower {Z2}, C2, A)	5 axes(Upper X1, Z1, C1, B, Y) + 4 axes(Lower X2, Z2, C2, A)	
Data input/output	Fast data server		○	○	○	○	○	○	
	Memory card input/output		●	●	●	●	●	●	
	USB memory input/output		●	●	●	●	●	●	
	Larger capacity memory_2GB	not CUFOS only (15" display)	○	○	○	○	○	○	
	SSD data server	CUFOS only (19" display)	○	○	○	○	○	○	
Interface function	Embedded Ethernet		○	●	●	●	●	●	
	Fast Ethernet		○	○	○	○	○	○	
	Enhanced Embedded Ethernet function		●	●	●	●	●	●	
Operation	DNC operation	Included in RS232C interface.	●	●	●	●	●	●	
	DNC operation with memory card	G5.1 Q_, 600 Blocks	●	●	●	●	●	●	
	AI contour control II								
Feed function	AI contour control II	G5.1 Q_, 1000 Blocks	●	●	●	●	●	●	
	High-speed smooth TCP		X	X	X	●	●	●	
Operation Guidance Function	EZ Guide i (Conversational Programming Solution)		●	●	●	●	●	●	
	iHMI with Machining Cycle		●	●	●	●	●	●	
	EZ Operation package		●	●	●	●	●	●	
Setting and display	CNC screen dual display function		●	●	●	●	●	●	
Network	FANUC MTConnect		⊛	⊛	⊛	⊛	⊛	⊛	
	FANUC OPC UA		⊛	⊛	⊛	⊛	⊛	⊛	
Others	Display unit (Note *2)	15" color LCD with Touch Panel	⊛	⊛	⊛	⊛	⊛	⊛	
		19" color LCD with Touch Panel	⊛	⊛	⊛	⊛	⊛	⊛	
	Part program storage size & Number of registerable programs	1280M(512KB)_1000 programs		X	X	X	X	X	X
		2560M(1MB)_1000 programs		X	X	X	X	X	
		5120M(2MB)_1000 programs		X	X	X	X	X	
		10240M(4MB)_1000 programs		●	●	●	●	●	
		20480M(8MB)_1000 programs		○	○	○	○	○	
		10240M(4MB)_4000 programs		○	○	○	○	○	
20480M(8MB)_4000 programs		○	○	○	○	○			

Note *2) CUFOS specification have 19" color LCD with Touch Panel

CONVENIENT OPERATION

FANUC 31i/32i PLUS

EZ WORK function

Tool load monitoring, Setup guide, Status monitoring, Operation and Recovery guide can provide more convenience and efficiency increasing for user operation.



Tool load monitoring

Real-time tool load monitoring and display various tooling information.



Operation and Recovery guide

Provides step-by-step operation guides and help so even unskilled users can operate it safely and easily.

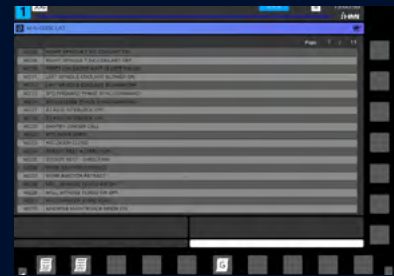

Thermal Compensation

Improve the machining precision through temperature sensor detection and deflection compensation of the structure in real-time.



Status monitoring

Real-time confirmation of machine operation abnormality for effective maintenance using actuator/sensor base operation status notifications.



Setup guide

Displays the operation status up to now and guides the next step when setting up the machine.

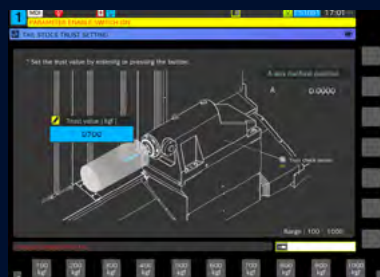

CONVENIENT OPERATION

SIEMENS 840D

21.5 inch display + New OP

Two path programs are displayed simultaneously in the large 21.5-inch screen for enhanced user convenience.

- 21.5-inch display
- 6GB user memory
- USB (standard)
- QWERTY keyboard



Convenient conversational functionality

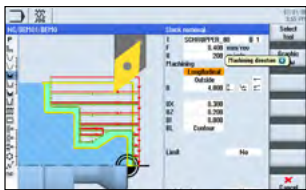

Shopmill / Shopturn

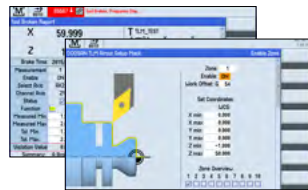

Tool load monitoring

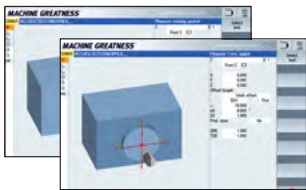

Measuring cycle

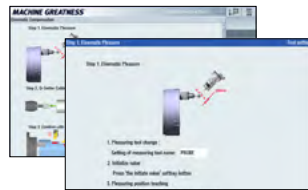

Intelligent kinematic compensation function

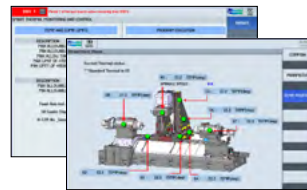

Temperature compensation function



Collision avoidance function

NUMERIC CONTROL SPECIFICATIONS

SIEMENS

Description	Item	Specifications	STD	S	ST
			S840D	S840D	S840D
Controlled axis	Controlled axes		X1, Z1, Y1, B1, C1, C3, W1, MG1, MG2, ARM, SH	X1, Z1, Z3, Y1, B1, C1, C2, C3, W1, MG1, MG2, ARM, SH	X1, X2, Z1, Z2, Z3, Y1, B1, C1, C2, C3, C4, MG1, MG2, MG3, ARM, SH
	Simultaneously controlled axes		5 axes	5 axes	5 axes
Data input/output	Memory card input/output		X	X	X
	USB memory input/output		●	●	●
Interface function	Ethernet	(X130)	●	●	●
	On network drive	(without EES option, Extcall)	●	●	●
Operation	On USB storage medium, e.g. memory stick	(without EES option, Extcall)	●	●	●
	Workpiece coordinate system	G54 - G59, G507 - G599	●	●	●
Feed function	Advanced surface		●	●	●
	Top surface		○	○	○
Programming & editing function	Look ahead number of block		1000	1000	1000
	3D simulation, finished part		●	●	●
Operation guidance function	Simultaneous recording		●	●	●
	DXF reader for pC integrated in SINUMERIK operate		○	○	○
Setting and display	Shopturn		●	●	●
	EZ operation package		●	●	●
Network	Operation via a VNC viewer		●	●	●
	MTConnect		⊕	⊕	⊕
Others	OPCUA		○	○	○
	Display unit	19" color display without touch screen(SW4.9)	X	X	X
		21.5" color display with touch screen(SW4.9)	●	●	●
		CNC user memory 10 MB	●	●	●
		CNC user memory 100 MB	○	○	○
	Part program storage size	CNC user memory 6GB	○	○	○
	CNC user memory 40GB (with PCU or IPC)	○	○	○	
	CNC user memory without limit (Execution from external storage devices) (EES / Using by USB or network)	○	○	○	
	HMI user memory for CNC part program 6GB	●	●	●	

STANDARD | OPTIONAL SPECIFICATIONS

A range of options is available to suit individual requirements.

Description	Specifications	SMX2100	SMX2100S	SMX2100ST	SMX2100B	SMX2100SB	SMX2100STB	
Tool shank	CAPTO C6	●	●	●	●	●	●	
	HSK-A63	consultation	consultation	consultation	consultation	consultation	consultation	
Automatic tool changer	7" operation touch panel	●	●	●	●	●	●	
	10.4" operation touch panel (including a camera in the magazine)	○	○	○	○	○	○	
Tool magazine	40 tools	●	●	●	●	●	●	
	80 tools	○	○	○	○	○	○	
	120 tools	○	○	○	○	○	○	
Low turret	12 stations turning	●	●	●	●	●	●	
	12 stations turn-milling (BMT55P, 5000 r/min)	○	○	○	○	○	○	
	12 stations turn-milling (BMT55P, 10000 r/min)	○	○	○	○	○	○	
	12 stations /24 Positioning turn-milling (BMT55P, 5000 r/min)	○	○	○	○	○	○	
	12 stations/24 Positioning turn-milling(BMT55P, 10000 r/min)	○	○	○	○	○	○	
Work holding device	Left spindle	Hydraulic chuck 8"	●	●	●	X	X	X
		Hydraulic chuck 10"	○	○	○	●	●	●
		Hydraulic chuck 12"	X	X	X	○	○	○
	Right spindle	Hydraulic chuck 8"	X	●	●	X	●	●
		Hydraulic chuck 10"	X	○	○	X	○	○
		Hydraulic chuck 12"	X	X	X	X	X	X
	Dual pressure chucking (High pressure / Low pressure)		○	○	○	○	○	○
	Chuck clamp & Unclamp confirmation		●	●	●	●	●	●
Servo driven steady rest		○	○	X	○	○	X	
V stand for sha workpiece		○	○	○	○	○	○	
Coolant	T-T-C (Milling spindle)	Pressure 1.0MPa (145 psi)/ Bag filter	●	●	●	●	●	
		Pressure 3.0MPa (435 psi)/Cyclone filter	○	○	○	○	○	
		Pressure 7.0MPa (1015 psi) / Cyclone filter	○	○	○	○	○	
		Pressure 7.0MPa (1015 psi)/Paper filter	○	○	○	○	○	
	MQL (Minimum quantity lubrication) system		○	○	○	○	○	
	For Lower turret	Pressure 0.45MPa (65.2psi) / Tank screen filter	X	X	●	X	X	●
		Pressure 0.7 / 1.0 / 1.45 Mpa(101.5/145/151.1 psi)/ Tank screen filter	X	X	○	X	X	○
Oil skimmer		○	○	○	○	○	○	
Coolant pressure switch (Standard for milling spindle / option for lower turret)		●	●	● (lower turret : ○)	●	●	● (lower turret : ○)	
Lower turret coolant filter		X	X	○	X	X	○	
Coolant level switch : Sensing level - Low		○	○	○	○	○	○	
Chip disposal	Chip conveyor (Right disposal)		○	○	○	○	○	
	Chip bucket		○	○	○	○	○	
	Air blower (for Left or Right spindle chuck)		●	●	●	●	●	
	Chuck coolant (for Left or Right spindle chuck)		○	○	○	○	○	
	Through spindle air shower (Left or Right)		○	○	○	○	○	
	Through spindle coolant (Left or Right)		○	○	○	○	○	
	Shower coolant (0.75kW, 85 liter/min)		○	○	○	○	○	
	Coolant gun		○	○	○	○	○	
	Air gun		○	○	○	○	○	
	Mist collector		○	○	○	○	○	
High accuracy	Thermal compensation		●	●	●	●	●	
	Ball screw core cooling (X-axis)		●	●	●	●	●	
	Ball screw core cooling (Y/Z-axis)		○	○	○	○	○	
	Coolant chiller (Coolant Chiller, Temperature control)		○	○	○	○	○	
	Linear scale (X1-axis)		○	○	○	○	○	
	Linear scale (X2-axis)		X	X	○	X	X	
Linear scale (Y / Z-axis)		○	○	○	○	○		
Oil cooler cooling flow detector		○	○	○	○	○		
Measurement	Auto tool setter(Milling spindle,Touch)		○	○	○	○	○	
	Auto tool setter(Milling spindle, Non-contact, NC4 or BLUM)		○	○	○	○	○	
	Auto tool setter (Low turret)		X	X	○	X	X	
	Removable tool setter (Low turret)		X	X	○	X	X	
Auto workpiece measurement (RMP60)		○	○	○	○	○		
Automation	Parts unloader and conveyor(both left & right spindle direction, pocket type or gripper type)		X	○	○	X	○	
	Workpiece ejector (TSC/TSA selectable)		X	○	○	X	○	
	Bar feeder interface		○	○	○	○	○	
	Robot interface		○	○	○	○	○	
Automatic front door (with safety device)		○	○	○	○	○		
Others	DN Solutions tool monitoring system		●	●	●	●	●	
	Rotary type window wipe		○	○	○	○	○	
	Intelligent kinematic compensation for multi-tasking (Software customized by DN Solutions)		●	●	●	●	●	
	Intelligent geometric compensation for multi-tasking(Datum ball gage)		○	○	○	○	○	
	Quick change tooling(Low turret, CAPTO)		X	X	○	X	X	
	AUTOMATIC POWER OFF		○	○	○	○	○	
Standard accessories	Display unit size 15 inch(Fanuc)		●	●	●	●	●	
	19 inch(Fanuc, CUFOS)		○	○	○	○	○	
	21.5 inch(Siemens)		●	●	●	●	●	
ADDITIONAL PORTABLE MPG		●	●	●	●	●		
Customized special option	Foundation bolt for anchoring		●	●	●	●	●	
	Air limit sensing on chuck_Preparation		○	○	○	○	○	
	Tool setter extension for special chuck (Low turret)		○	○	○	○	○	
	Left/Right spindle air curtain		○	○	○	○	○	
	Coolant for milling spindle_Multi pressure		○	○	○	○	○	
	Tool ID check system_Manual		○	○	○	○	○	
Additional work light for ATC magazine		○	○	○	○	○		
Angular head for milling spindle_ATC		○	○	○	○	○		

● Standard ● Optional X Not applicable

STANDARD | OPTIONAL SPECIFICATIONS

A range of options is available to suit individual requirements.

Description	Specifications	SMX 2600	SMX 3100	SMX 3100L	SMX 2600S	SMX 3100S	SMX 3100LS	SMX 2600ST	SMX 3100ST	
Tool shank	CAPTO C6	●	●	●	●	●	●	●	●	
	HSK-A63	○	○	○	○	○	○	○	○	
Automatic tool changer	7" operation touch panel	●	●	●	●	●	●	●	●	
	10.4" operation touch panel (including a camera in the magazine)	○	○	○	○	○	○	○	○	
Tool magazine	40 tools	●	●	●	●	●	●	●	●	
	80 tools	○	○	○	○	○	○	○	○	
	120 tools	○*	○*	○*	○*	○*	○*	○*	○*	
Tool magazine for long boring bar	3 tools	X	X	○	X	X	○	X	X	
Low turret	12 stations turning	X	X	X	X	X	X	●	●	
	12 stations turn-milling (BMT65P)	X	X	X	X	X	X	○	○	
Work holding device	Left spindle	Hydraulic chuck 10"	●	X	X	●	X	X	●	X
		Hydraulic chuck 12"	○	●	●	○	●	○	○	●
		Hydraulic chuck 15"	X	○	○	X	○	○	X	○
	Right spindle	Hydraulic chuck 10"	X	X	X	●	●	●	●	●
		Hydraulic chuck 12"	X	X	X	○	○	○	○	○
	Dual pressure chucking (High pressure / Low pressure)		○	○	○	○	○	○	○	○
	Chuck clamp & Unclamp confirmation		○	○	○	○	○	○	○	○
	Servo driven steady rest (SLU3.1~SLU5) - parking function NOT available		○	○	○	○	○	○	X	X
	Servo driven steady rest (SLU5.1 or K5.0 or K5.1) - with parking function		X	X	○	X	X	○	X	X
	Servo driven steady rest (SLU3Z or 3.1Z or 3.2Z) - Lower turret		X	X	X	X	X	X	○	○
V stand for sha workpiece		○	○	○	○	○	○	○	○	
Coolant	T-T-C (Milling spindle)	Pressure 1.0MPa (145 psi) / Bag filter	●	●	●	●	●	●	●	
		Pressure 3.0MPa (435 psi) / Cyclone filter	○	○	○	○	○	○	○	○
		Pressure 7.0MPa (1015 psi) / Cyclone filter	○	○	○	○	○	○	○	○
		Pressure 7.0MPa (1015 psi) / Paper filter	○	○	○	○	○	○	○	○
		MQL (Minimum quantity lubrication) system	○	○	○	○	○	○	○	○
	For Lower turret	Pressure 0.45MPa (65.2psi) / Tank screen filter	X	X	X	X	X	X	●	●
		Pressure 0.7 / 1.0 / 1.45 MPa (101.5/145/151.1 psi) / Tank screen filter	X	X	X	X	X	X	○	○
		Oil skimmer	○	○	○	○	○	○	○	○
Coolant pressure switch (Standard for milling spindle / option for lower turret)		●	●	●	●	●	●	●	●	
Lower turret coolant filter		X	X	X	X	X	X	○	○	
Coolant level switch : Sensing level - Low		●	●	●	●	●	●	●	●	
Chip disposal	Chip conveyor (Right disposal)		○	○	○	○	○	○	○	
	Chip bucket		○	○	○	○	○	○	○	
	Air blower (for Left or Right spindle chuck)		●	●	●	●	●	●	●	
	Chuck coolant (for Left or Right spindle chuck)		○	○	○	○	○	○	○	
	Through spindle air shower (Left or Right)		○	○	○	○	○	○	○	
	Through spindle coolant (Left or Right)		○	○	○	○	○	○	○	
	Shower coolant (0.75kW, 85 liter/min)		○	○	○	○	○	○	○	
	Coolant gun		○	○	○	○	○	○	○	
	Air gun		○	○	○	○	○	○	○	
	Mist collector		○	○	○	○	○	○	○	
	Thermal compensation		●	●	●	●	●	●	●	
	High accuracy	Ball screw core cooling (X-axis)		●	●	●	●	●	●	●
Ball screw core cooling (Y/Z-axis)		○	○	○	○	○	○	○		
Coolant chiller (Coolant Chiller, Temperature control)		○	○	○	○	○	○	○		
Linear scale (X1-axis)		○	○	○	○	○	○	○		
Linear scale (X2-axis)		X	X	X	X	X	X	○		
Linear scale (Y / Z-axis)		○	○	○	○	○	○	○		
Measurement	Oil cooler cooling flow detector		○	○	○	○	○	○	○	
	Auto tool setter (Milling spindle, Touch)		○	○	○	○	○	○	○	
	Auto tool setter (Milling spindle, Non-contact, NC4 or BLUM)		○	○	○	○	○	○	○	
	Auto tool setter (Low turret)		○	○	○	○	○	○	○	
	Removable tool setter (Low turret)		○	○	○	○	○	○	○	
Automation	Auto workpiece measurement (RMP60)		○	○	○	○	○	○	○	
	Parts unloader and conveyor (pocket type or gripper type)		X	X	X	○	○	X	○	
	Workpiece ejector (TSC/TSA selectable)		X	X	X	○	○	X	○	
	Bar feeder interface		○	○	○	○	○	○	○*	
Others	Automatic front door (with safety device)		○	○	○	○	○	○	○	
	DN Solutions tool monitoring system		●	●	●	●	●	●	●	
	Rotary type window wipe		○	○	○	○	○	○	○	
	Intelligent geometric compensation for multi-tasking (Software customized by DN Solutions)		●	●	●	●	●	●	●	
	Intelligent geometric compensation for multi-tasking (Datum ball gage)		○	○	○	○	○	○	○	
	Quick change tooling (Low turret, CAPTO)		○	○	○	○	○	○	○	
	Display unit size	15 inch (Fanuc)	●	●	●	●	●	●	●	
		19 inch (Fanuc, CUFOS)	○	○	○	○	○	○	○	
21.5 inch (Siemens)		●	●	●	●	●	●	●		
Standard accessories	Foundation bolt for anchoring		●	●	●	●	●	●		
	Air limit sensing on chuck Preparation		○	○	○	○	○	○		
Customized special option	Tool setter extension for special chuck		X	X	X	X	X	○		
	Main/Left spindle air curtain		○	○	○	○	○	○		
	Sub/Right spindle air curtain		X	X	X	○	○	○		
	Coolant for milling spindle Multi pressure		○	○	○	○	○	○		
	Tool ID check system Manual		○	○	○	○	○	○		
	Additional work light for ATC magazine		○	○	○	○	○	○		
Angular head for milling spindle_ATC		○	○	○	○	○	○			

* Bar feeder interface is not available if 120 tools magazine is applied on the machine.

● Standard ● Optional X Not applicable

PERIPHERAL EQUIPMENT

Tailstock application for lower turret OPTION

- Steady rest to support long and slim components, and for improving machining stability
- Tailstock application for lower turret is available for SMX 2600ST/3100ST. OPTION



Tool setter (Automatic) OPTION

Auto linear motion type tool setter has been installed for tool measurement and tool wear detection. It is stored in a safe location during the machining process, and can be activated with the workpiece still in place in the chuck with no interference.

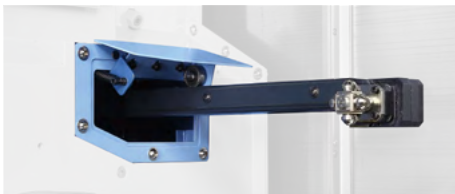

Gear skiving solutions

Dramatic improvements in productivity for gear skiving solutions such as power skiving, invo-milling and hobbing are available - enabling high-precision external / internal gear machining in a single setup.



* Please contact to DN Solutions on further information.

Linear scales OPTION

Linear scales are ideal for high accuracy simultaneous 5-axis machining, long machining runs and operation, and higher feed precision.

Quick change CAPTO OPTION

The quick change tool system simplifies tool change operations. Recommended for users who need to change tools frequently or to reduce set-up times.



* Lower turret applicable

Servo-driven steady rest OPTION

Steady rests support long workpieces during the machining process. Linear positioning of the steady rest is achieved by the servo motor and ball screw and can be positioned in cycle.



Servo-driven steady rest	SMX 2100 /S/B/SB	SMX 2100 ST/STB	SMX 2600/S	SMX 2600ST	SMX 3100/S	SMX 3100ST	SMX 3100L/LS
SLU-3.1 (Ø20-Ø165mm)	○	-	○	-	○	-	○
SLU-3.2 (Ø50-Ø200mm)	○	-	○	-	○	-	○
SLU-4 (Ø30-Ø245mm)	○	-	○	-	○	-	○
SLU-5 (Ø45-Ø310mm)	○	-	○	-	○	-	○
SLU-5.1 (Ø85-Ø350mm)	○	-	-	-	-	-	○ (Parking function)
K 5.0 (Ø80-Ø390mm)	-	-	-	-	-	-	○ (Parking function)
K 5.1 (Ø100-Ø410mm)	-	-	-	-	-	-	○ (Parking function)
Lower turret_SLU-3 (Ø12-Ø152mm)	-	○	-	○	-	○	-
Lower turret_SLU-3.1 (Ø20-Ø165mm)	-	○	-	○	-	○	-
Lower turret_SLU-3.2 (Ø50-Ø200mm)	-	-	-	○	-	○	-

Steady rest parking function*

When you don't want to use the steady rest, you can park it under the left chuck.

* This function is available for the SMX 3100L/LS.
The steady rest will be from the following SLU5.1, K5.0 and K5.1.

Chip conveyor (Right side exit) OPTION

The conveyor provides a superior chip removal system and has a stable structure for easy maintenance and reduced leakage. By selecting the correct type of conveyor, the efficiency of the machine is increased.

Name	Hinge belt	Magnetic scraper	Drum filter + Hinge scraper (Double type)
Application	For steel	For castings	For steel, castings, nonferrous metal
Features	<ul style="list-style-type: none"> General Appropriate for a heavy material chip of more than 30 mm in length 	<ul style="list-style-type: none"> Easy maintenance Eject the chip by scraping and raising the chip with the scraper 	<ul style="list-style-type: none"> Appropriate for both a long and a short chip Filtering coolant
Shape			

Coolant chiller (Recommendation) OPTION

Coolant chiller is highly recommended to prevent temperature rise and minimize thermal deformation, when using a water-insoluble coolant or high-pressure coolant system of which the power is over 1.5 kw.

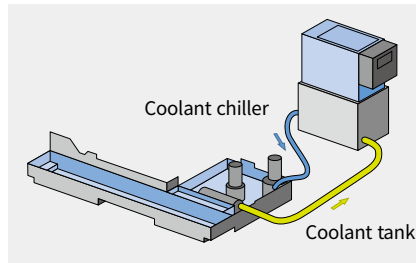

Optional equipment for automation OPTION

Peripheral equipment is available to support the SMX improve its performance and productivity.



POWER | TORQUE

FANUC 31i/32i PLUS

Left_SMX 2600/S/ST

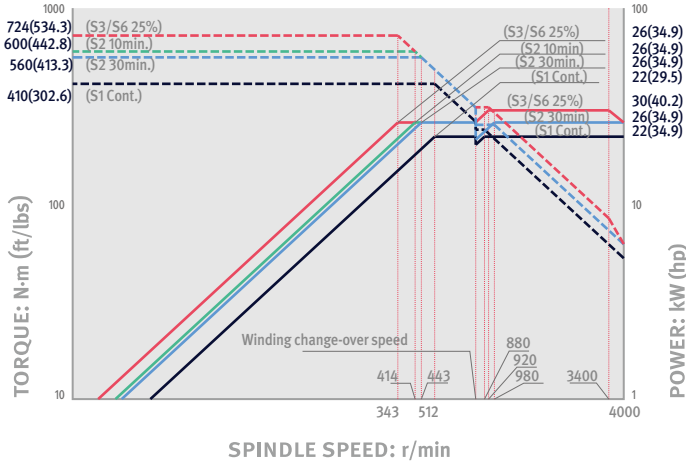

Left_SMX 3100/L/S/LS/ST

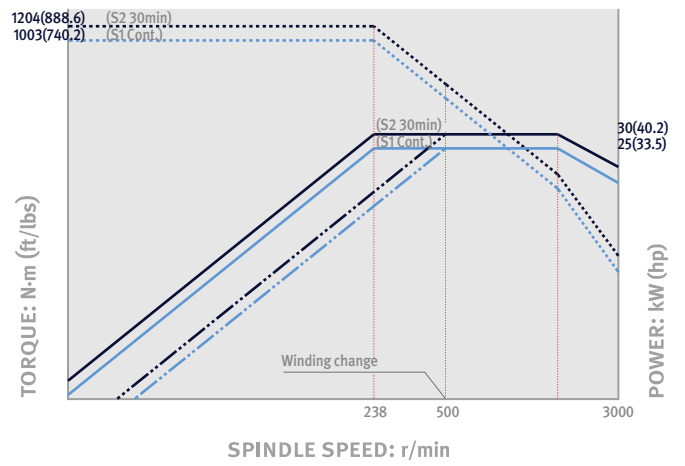

Right_SMX 2600S/ST · 3100S/LS/ST

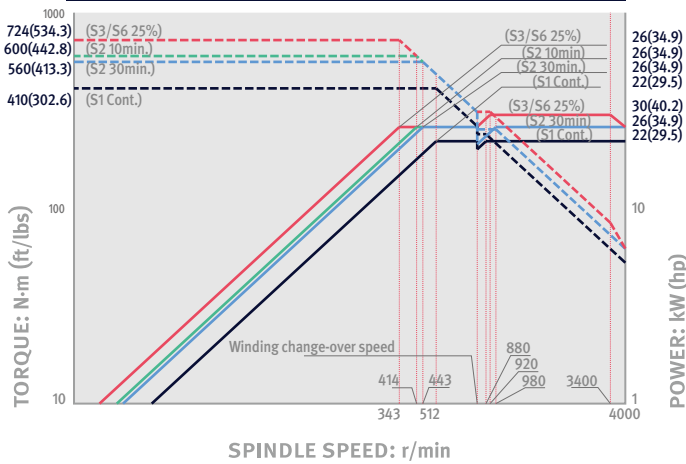

Milling_SMX 2600/S/ST · 3100/L/S/LS/ST

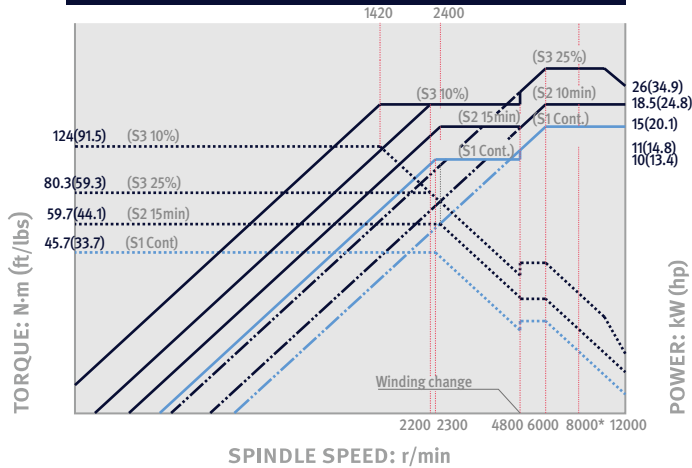

Rotary tool for lower turret (Milling)_SMX 2600ST · 3100ST OPTION

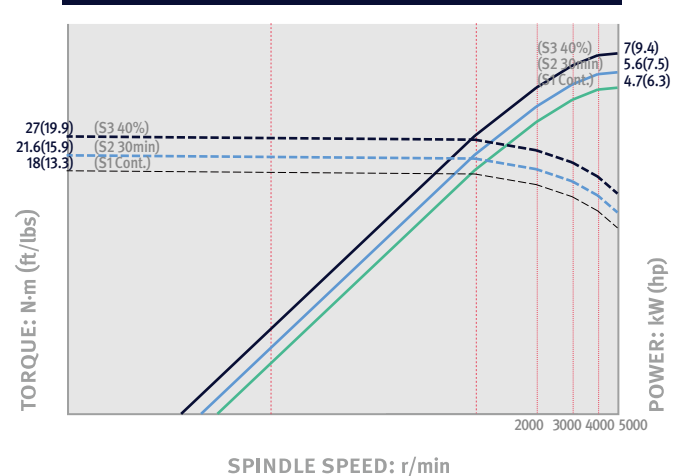

* 8000 r/min of Milling spindle is available as option. OPTION

POWER | TORQUE

SIEMENS

Left_SMX 2600/S/ST

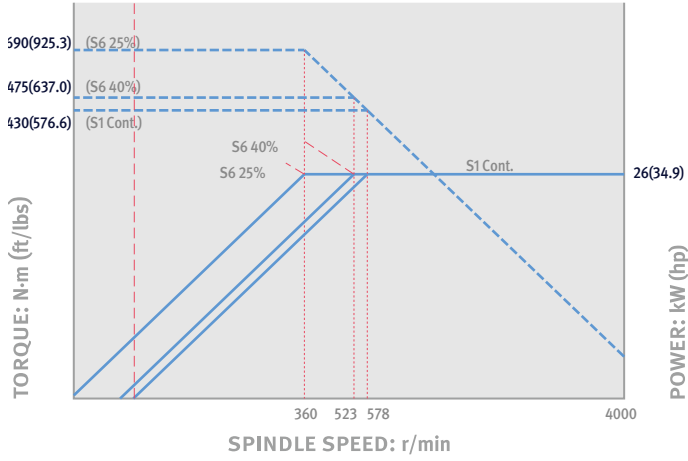

Left_SMX 3100/L/S/LS/ST

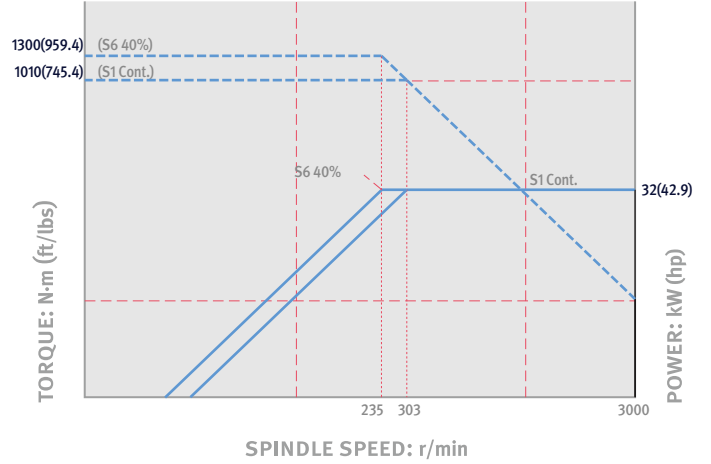

Right_SMX 2600S/ST · 3100S/LS/ST

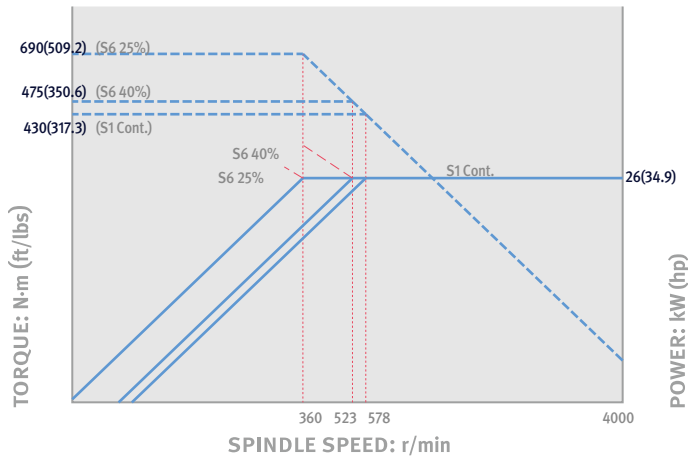

Lower turret_SMX 2600ST · 3100ST OPTION

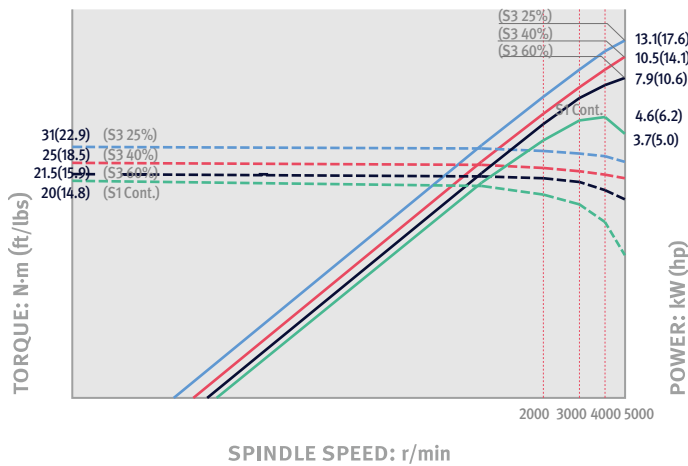

Milling_SMX 2600/S/ST · 3100/L/S/LS/ST

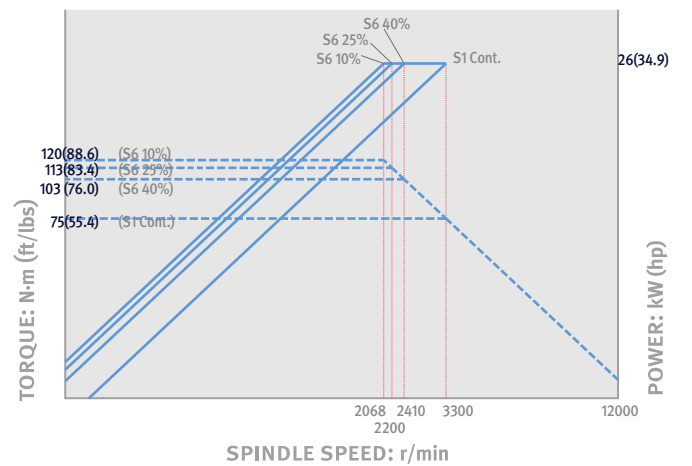

TOOL INTERFACE

SMX 2100ST· 2100STB

Unit : mm (inch)

For turning (12 stations)

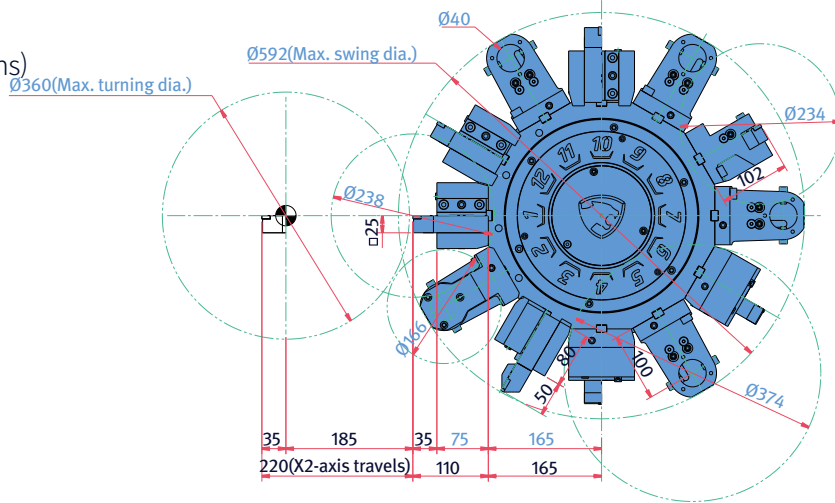

For turn-milling (12 stations, BMT55P)

OPTION

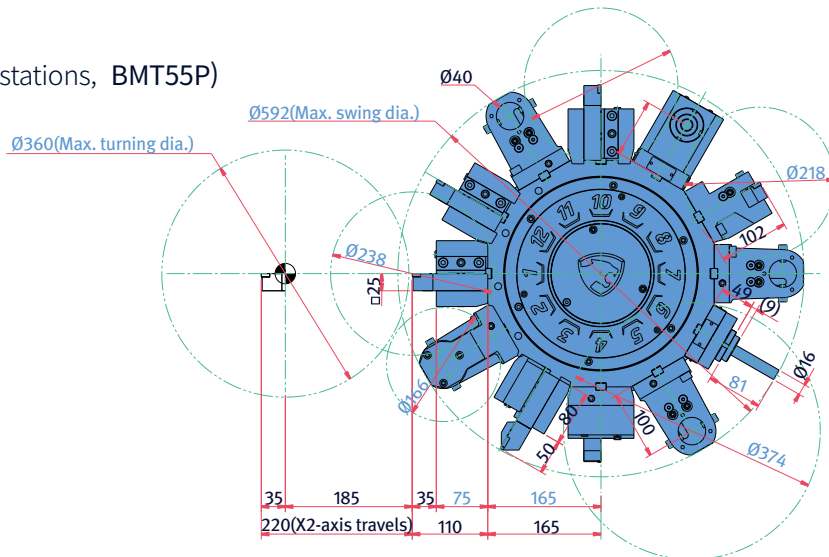

For turn-milling (12 stations, 24indexing BMT55P)

OPTION

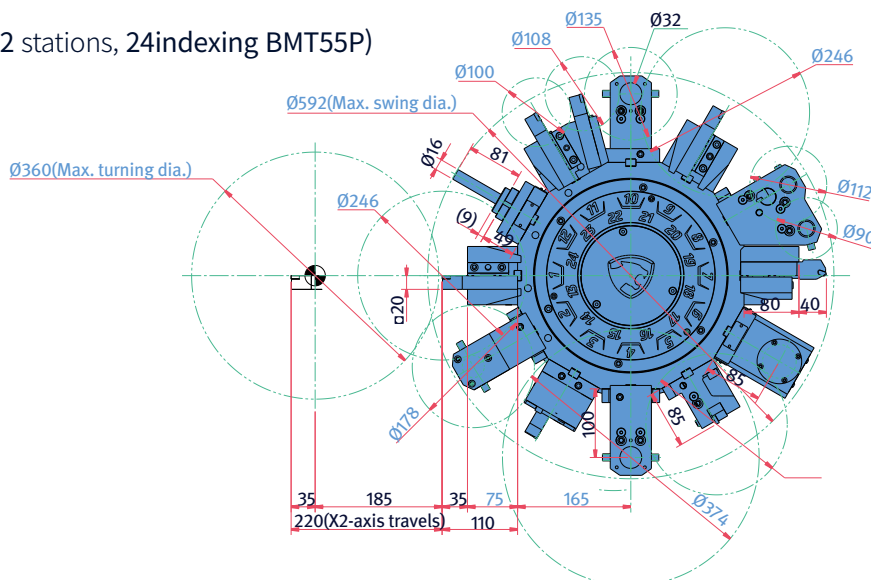

TOOL INTERFACE

SMX 2600ST · SMX 3100ST

Unit : mm (inch)

For turning (12 stations)

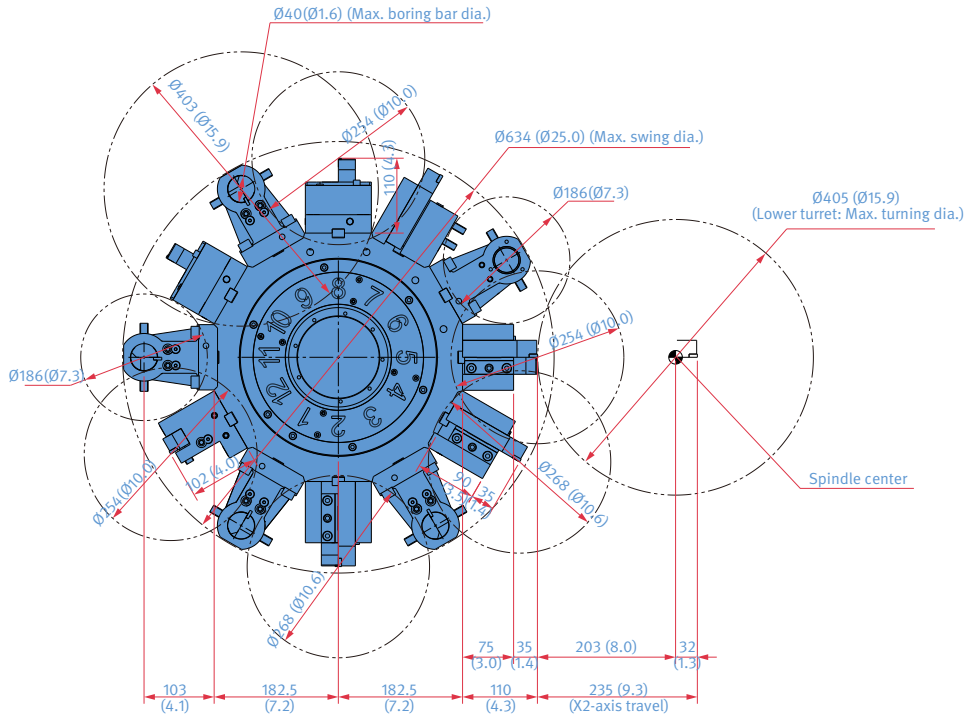

For turn-milling (12 stations, BMT65P)

OPTION

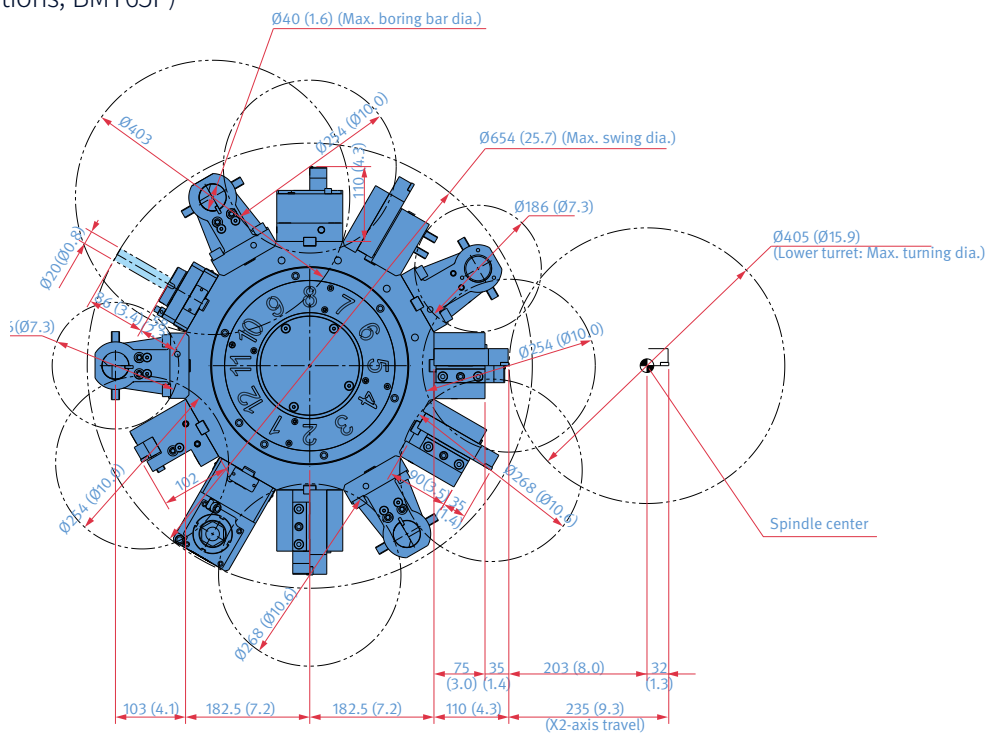

EXTERNAL DIMENSIONS

SMX 2100/S/ST/B/SB/STB

Unit : mm (inch)

TOP

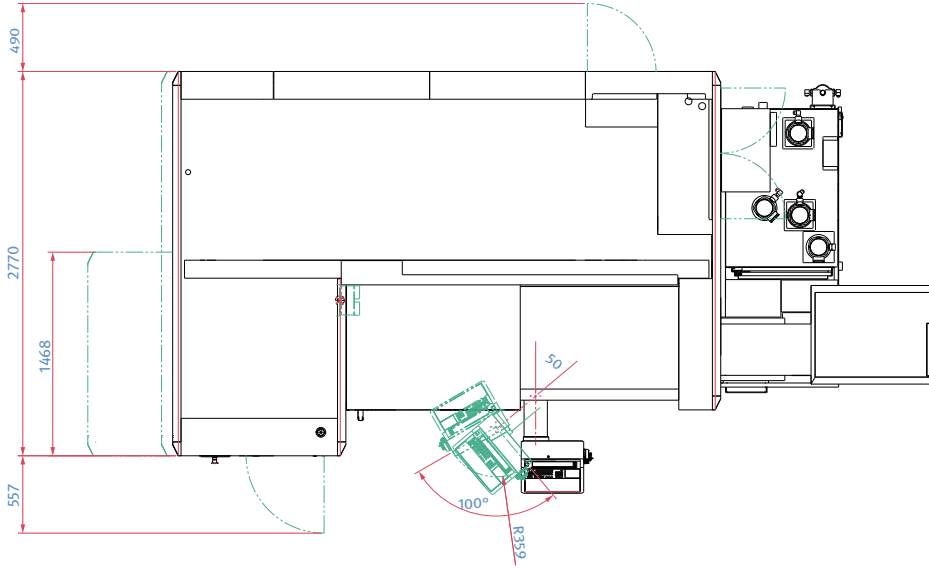

FRONT

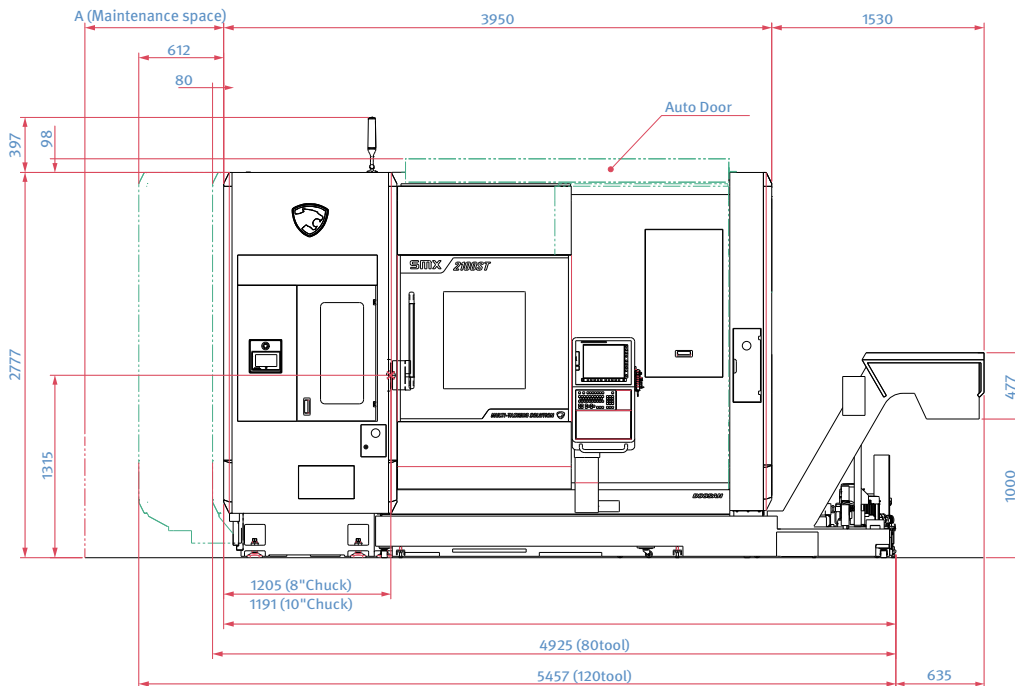

Maintenance space	A
40 tool	1000 (39.4)
80 tool	1080 (42.5)
120 tool	1612 (63.5)

Machine foundation : Anchoring is recommended to maintain accuracy over a long period of time. The anchor bolts and other related parts for foundation work are supplied as standard

items. Please consult with DN Solutions and sales technicians regarding ground and operating conditions.

* Some peripherals can be placed in different locations.

EXTERNAL DIMENSIONS

SMX 2600ST · 3100ST

Unit : mm (inch)

TOP

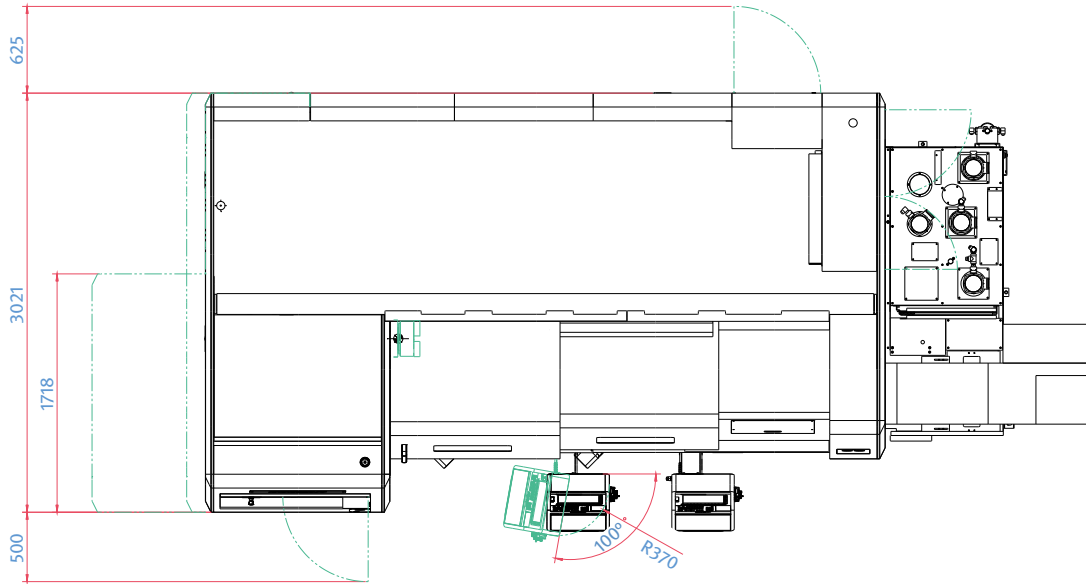

Maintenance space	D
40 tool	1000 (39.4)
80 tool	1135 (44.7)
120 tool	1817 (71.5)

Chip conveyor type	A	B	C
Hinge belt type	1498 (59.0)	1100 (43.3)	0
Drum filter+Hinge scraper type	2355 (92.7)	1100 (43.3)	70 (2.8)

FRONT

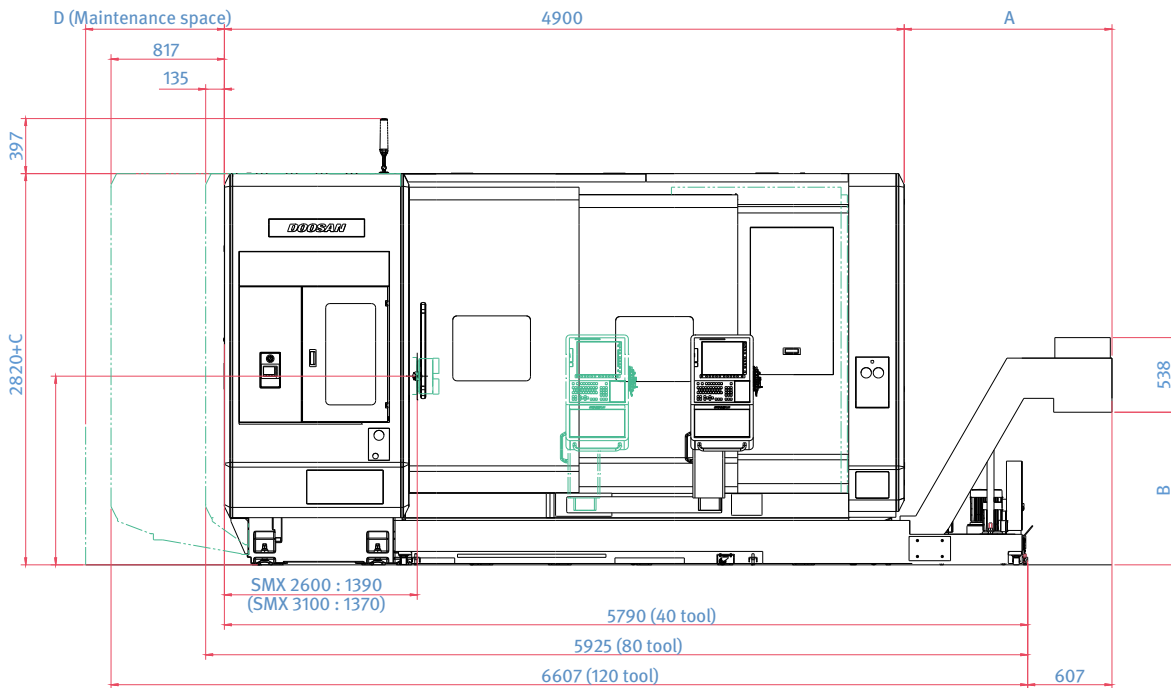

Machine foundation : Anchoring is recommended to maintain accuracy over a long period of time. The anchor bolts and other related parts for foundation work are supplied as standard

items. Please consult with DN Solutions and sales technicians regarding ground and operating conditions.

* Some peripherals can be placed in different locations.

TOOLING SYSTEM

SMX 2100ST/STB

Unit : mm (inch)

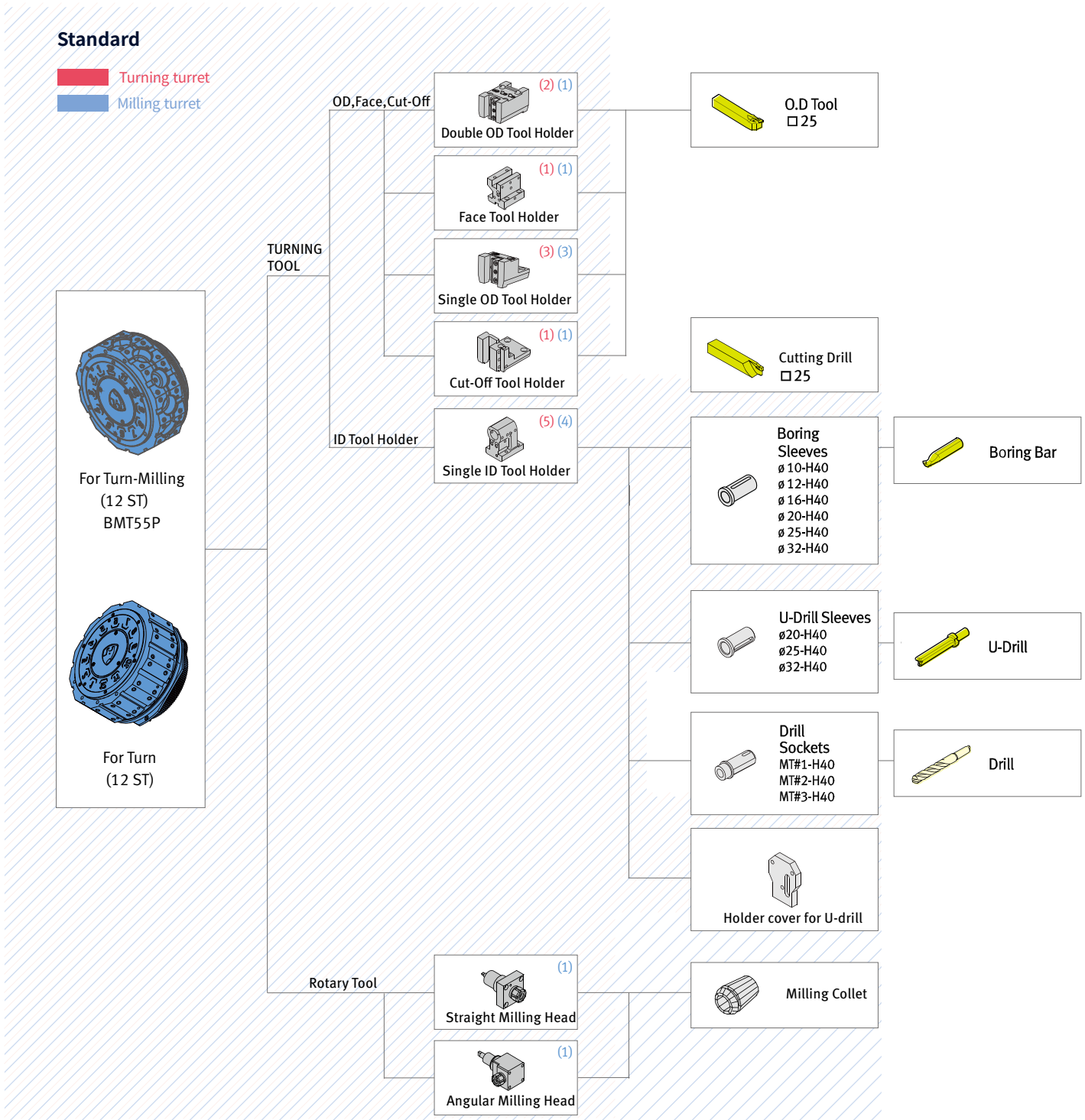

TOOLING SYSTEM

SMX 2100ST/STB

Unit : mm (inch)

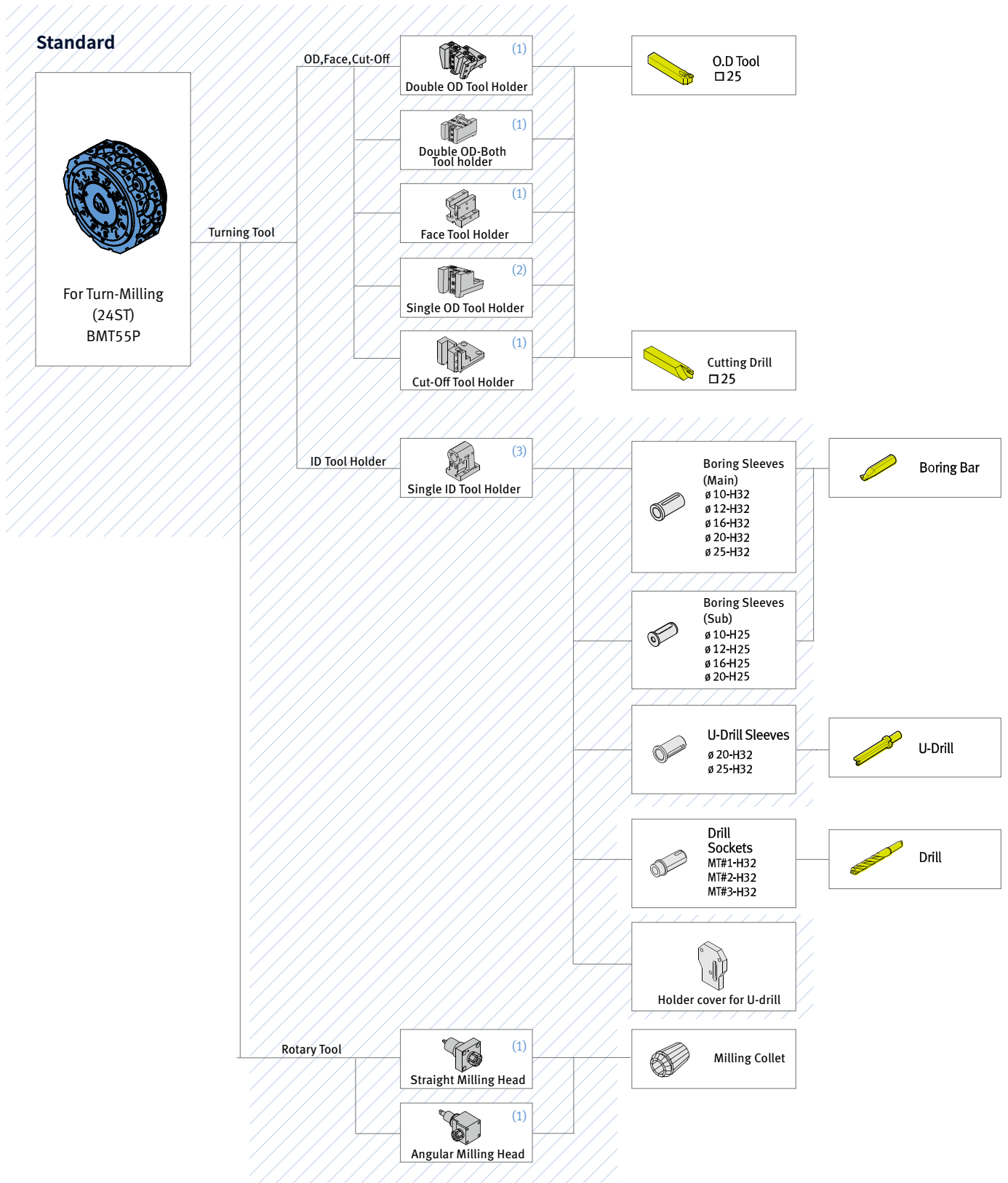

TOOLING SYSTEM

SMX 2600ST · 3100ST

Unit : mm (inch)

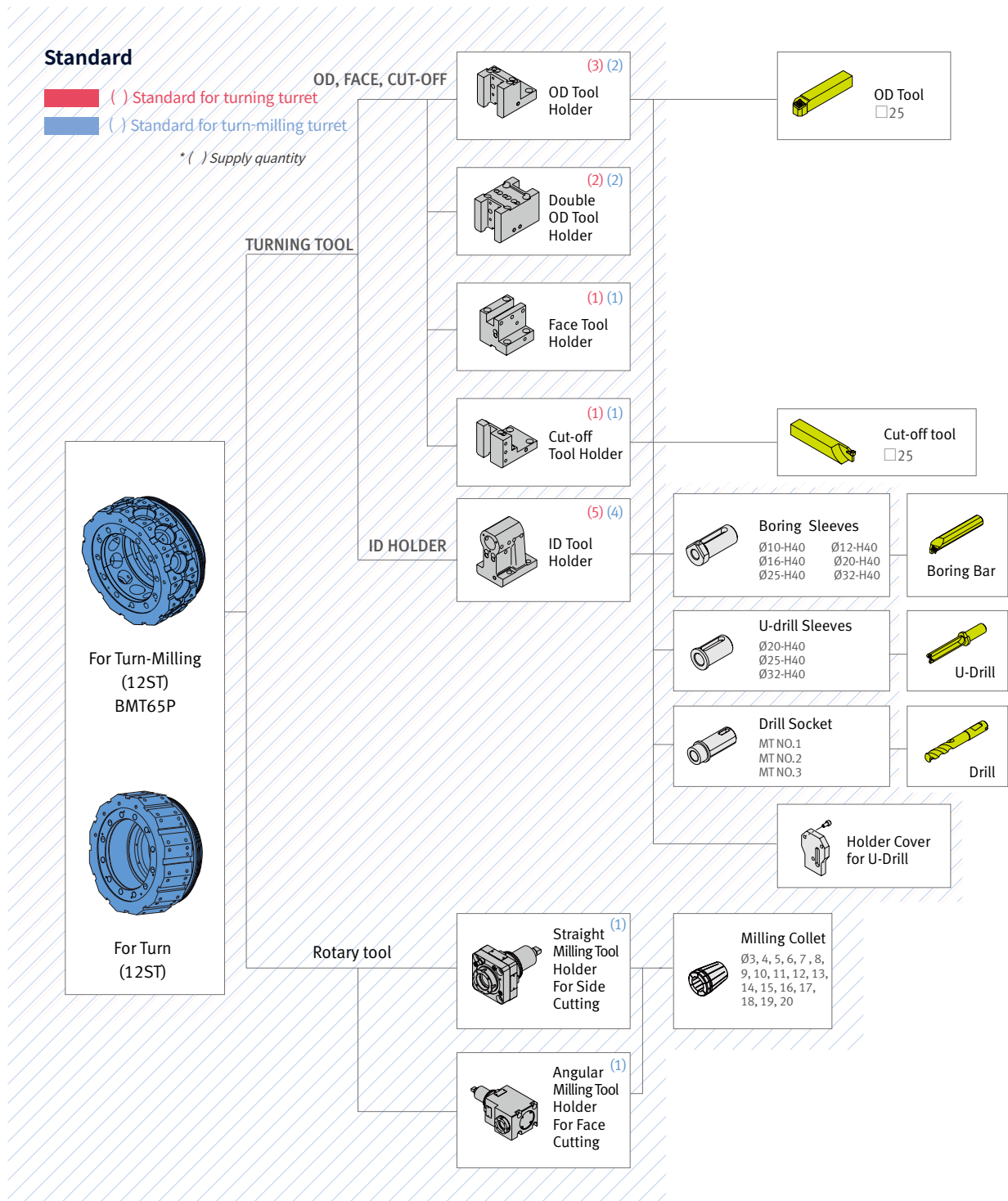

WORKING RANGE

SMX 2100/B/S/SB

Unit : mm (inch)

SMX 2100/B

ENTIRE RANGE

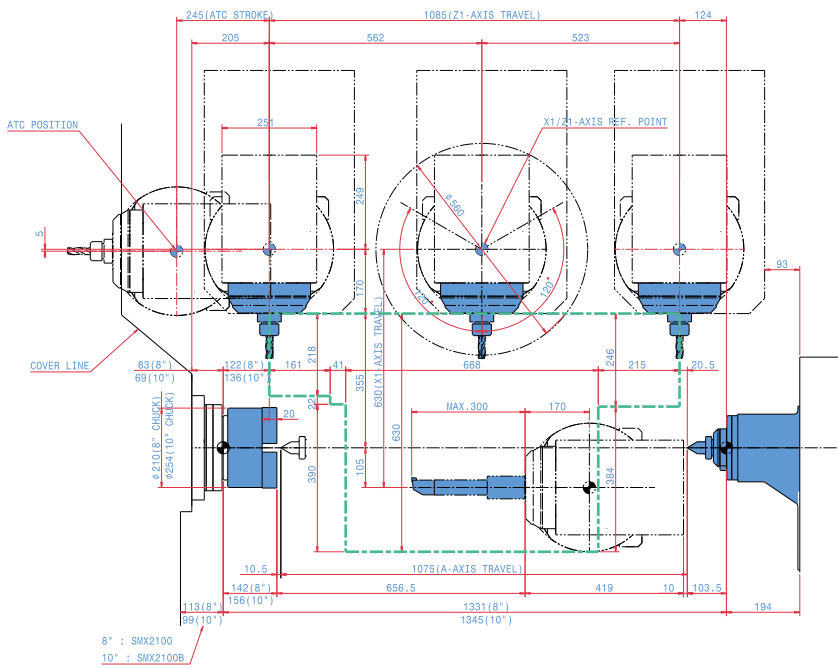

Y-AXIS WORKING RANGE

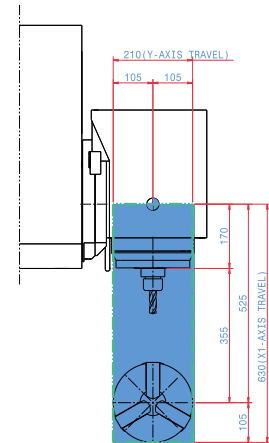

SMX 2100S/SB

ENTIRE RANGE

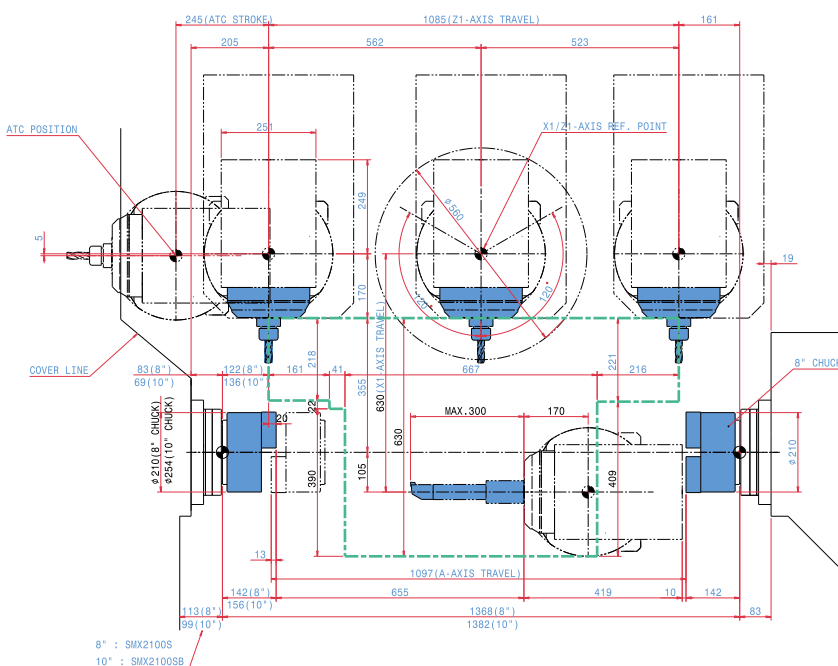

Y-AXIS WORKING RANGE

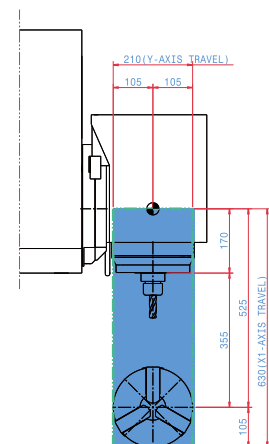

WORKING RANGE

SMX 2600 · 3100/L

ENTIRE RANGE

Unit : mm (inch)

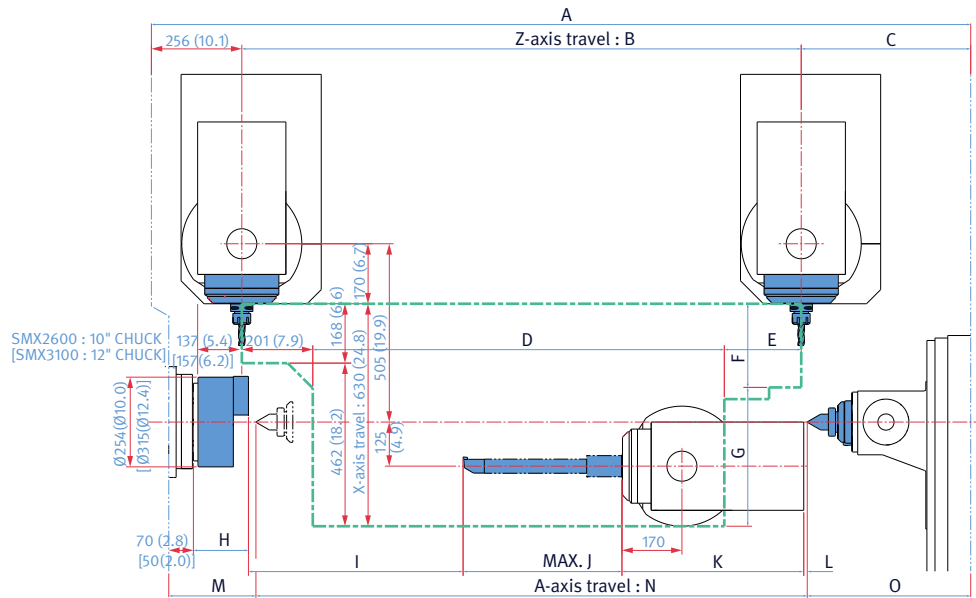

Model	A	B	C	D	E	F	G	H	I	J	K	L	M	N	O
SMX 2600	2321 (91.4)	1585 (62.4)	480 (18.9)	1166 (45.9)	218 (8.6)	237 (9.3)	393 (15.5)	156 (6.1)	608 (23.9)	450 (17.7)	515 (20.3)	10 (0.4)	247 (9.7)	1562 (61.5)	463 (18.2)
SMX 3100								176 (6.93)							
SMX 3100L	3223 (126.9)	2585 (101.8)	382 (15)	2168 (85.4)	216 (8.5)	195 (7.7)	435 (17.1)	176 (6.93)	1610 (63.4)*	450 (17.7)*	515 (20.3)	12 (0.5)	313 (12.3)	2500 (98.4)	361 (14.2)

* "I" and "J" can be different depends on an applied long boring bar.

Y-AXIS WORKING RANGE

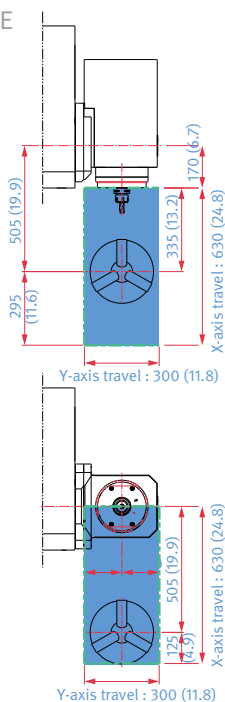

B-AXIS ROTATING RANGE

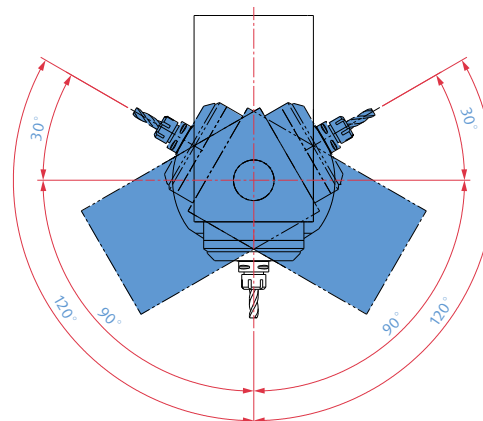

WORKING RANGE

SMX 2600S · 3100S/LS

ENTIRE RANGE

Unit : mm (inch)

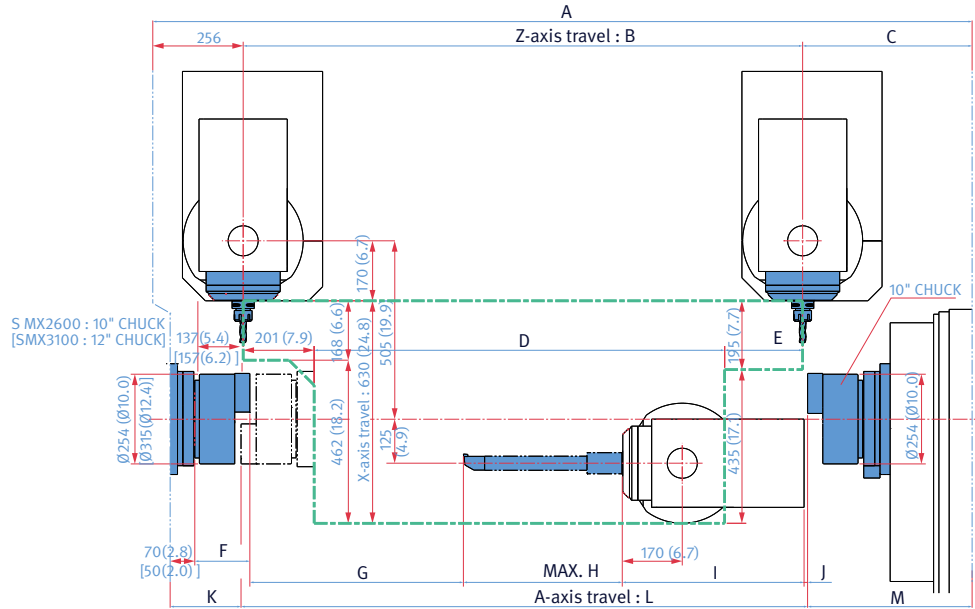

Model	A	B	C	D	E	F	G	H	I	J	K	L	M
SMX 2600S	2321 (91.4)	1585 (62.4)	480 (18.9)	1163 (45.8)	221 (8.7)	156 (6.1)	605 (23.8)	450 (17.7)	515 (20.3)	10 (0.4)	201 (7.9)	1605 (63.2)	466 (18.3)
SMX 3100S						176 (6.93)							
SMX 3100LS	3223 (126.9)	2585 (101.8)	382 (15)	2168 (85.4)	216 (8.5)	176 (6.93)	1610 (63.4)*	450 (17.7)*	515 (20.3)	10 (0.4)	311 (12.2)	2500 (98.4)	363 (14.3)

* "G" and "H" can be different depends on an applied long boring bar.

Y-AXIS WORKING RANGE

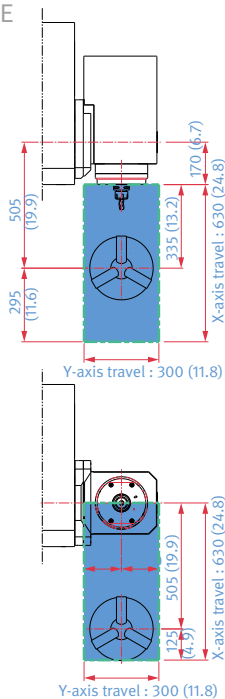

B-AXIS ROTATING RANGE

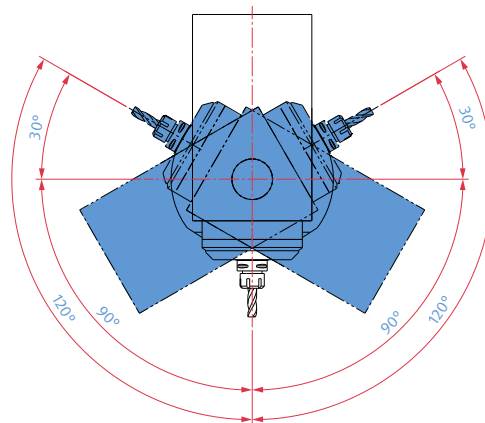

WORKING RANGE

SMX 2100ST/STB Lower turret

Unit : mm (inch)

ANGULAR MILLING HEAD

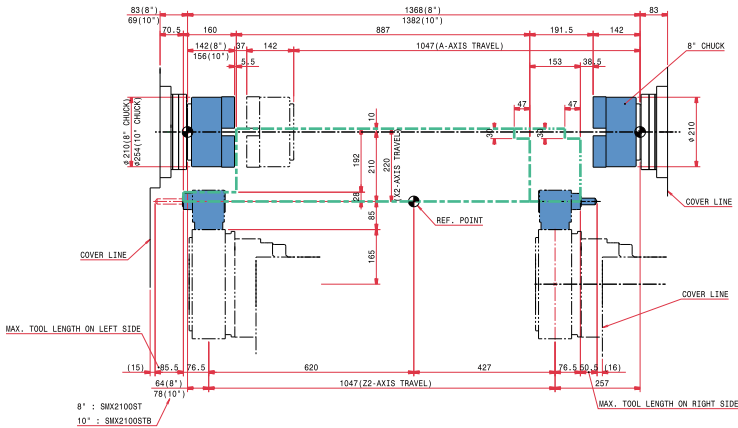

STRAIGHT MILLING HEAD

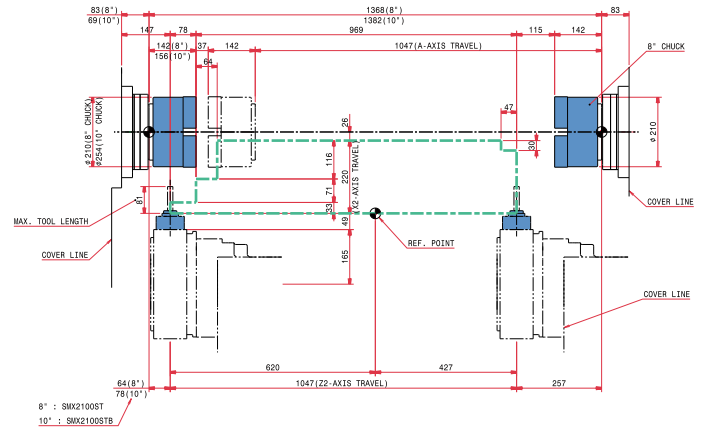

ID TOOL HOLDER

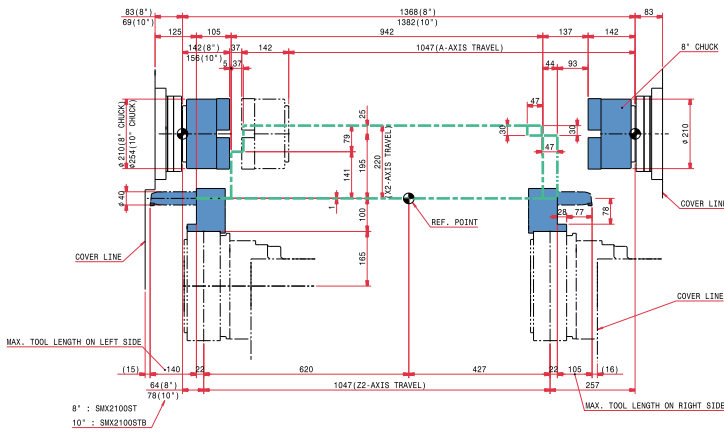

OD TOOL HOLDER

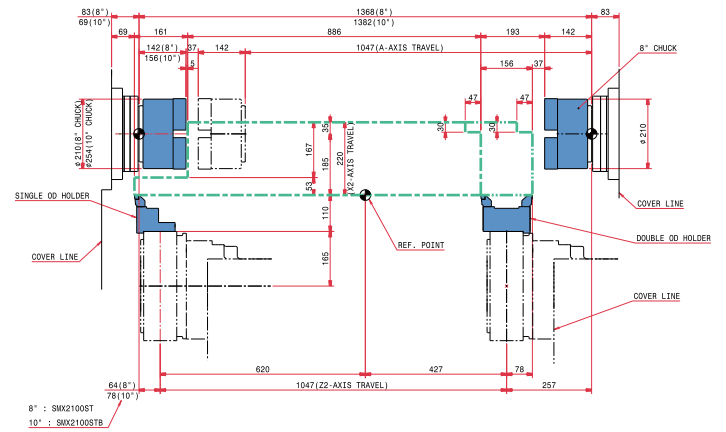

WORKING RANGE

SMX 2600ST · 3100ST Lower turret

Unit : mm (inch)

ANGULAR MILLING HEAD

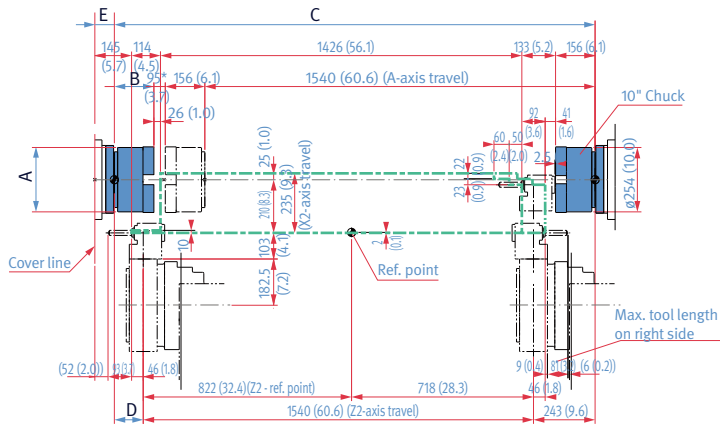

* Based on SMX 2600ST, SMX 3100ST : 95mm (3.7inch)

STRAIGHT MILLING TOOL HOLDER

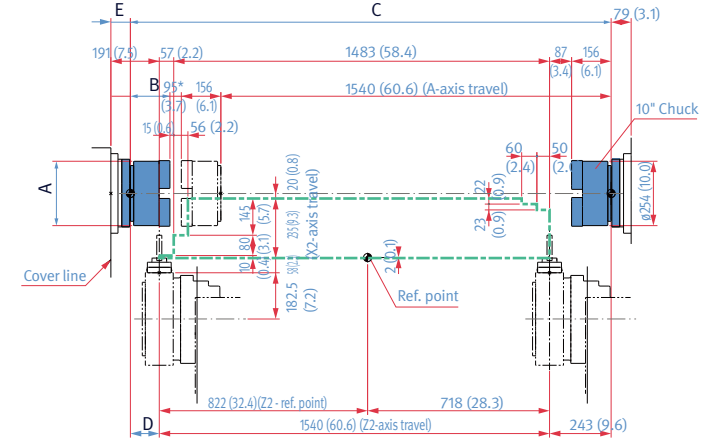

* Based on SMX 2600ST, SMX 3100ST : 95mm (3.7inch)

ID TOOL HOLDER

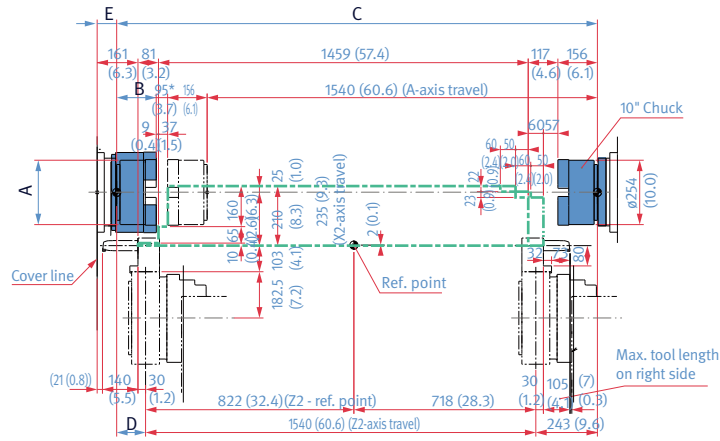

* Based on SMX 2600ST, SMX 3100ST : 95mm (3.7inch)

OD TOOL HOLDER

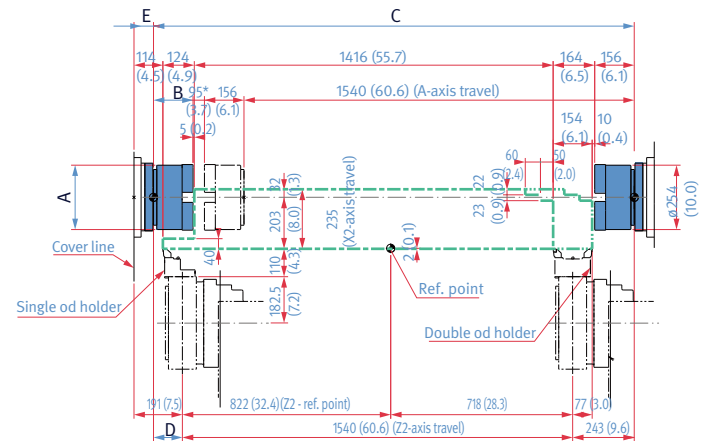

* Based on SMX 2600ST, SMX 3100ST : 95mm (3.7inch)

	Unit	A	B	C	D	E
SMX 2600ST (10"chuck)	mm (inch)	ø254 (10.0)	156 (6.1)	1897 (74.7)	114 (4.5)	77 (3.0)
SMX 3100ST (12" chuck)	mm (inch)	ø315 (12.4)	176.5 (6.9)	1917 (75.5)	134 (5.3)	57 (2.2)

MACHINE SPECIFICATIONS

SMX 2100 series

Item	Unit	SMX2100	SMX2100S	SMX2100ST	SMX2100B	SMX2100SB	SMX2100STB		
Capacity	Swing over bed	mm (inch)	600 (23.6)						
	Recom. turning diameter	mm (inch)	210 (8.3)		255 (10.0)				
	Max. turning diameter	mm (inch)	600 (23.6)						
	Max. turning length	mm (inch)	1040 (40.9)						
	Chuck size	Left spindle	inch	8			10		
		Right spindle	inch	-	8		8		
	Chuck work weight (include chuck)	kg (lb)	150 (330.7)			260 (573.2)			
	Shaft work weight (include chuck)	kg (lb)	300 (661.4)	-		520 (1146.4)		-	
Travels	Travel distance	Bar working diameter	mm (inch)	65 (2.6)		81 (3.2)			
		X-axis	mm (inch)	630(-105/+525) (24.8(-4.1/+20.7))					
		Y-axis	mm (inch)	210(±105) (8.3(±4.1))					
		Z-axis	mm (inch)	1085 (42.7)					
		A-axis	mm (inch)	-	1047 (41.2)		-	1047 (41.2)	
		B-axis	deg	240(±120)					
		C1-axis / C2-axis	deg	360 / -	360 / 360		360 / -		360 / 360
	X2-axis / Z2-axis	mm (inch)	- / -		220 / 1047 (8.7 / 41.2)		- / -		220 / 1047 (8.7 / 41.2)
	Rapid traverse rate	X-axis	m/min (ipm)	48 (1889.8)					
		Y-axis	m/min (ipm)	36 (1417.3)					
Z-axis		m/min (ipm)	48 (1889.8)						
A-axis		m/min (ipm)	-	30 (1181.1)		-	30 (1181.1)		
B-axis		r/min	40						
C1-axis / C2-axis		r/min	200 / -	200 / 200		200 / -		200 / 200	
X2-axis / Z2-axis		m/min (ipm)	- / -		24 / 36 (944.9 / 1417.3)		- / -		24 / 36 (944.9 / 1417.3)
Left spindle	Max. spindle speed	r/min	5000			4000			
	Spindle motor power (S3 15%/S3 25%/30min/cont.)	kW (Hp)	22 / 22 / 18.5 / 15 (29.5 / 29.5 / 24.8 / 20.1)			22 / 22 / 22 / 15 (29.5 / 29.5 / 29.5 / 20.1)			
	Spindle nose	ASA	A2-6			A2-8			
	Spindle bearing diameter (Front)	mm (inch)	110 (4.3)			130 (5.1)			
	Spindle through hole	mm (inch)	76 (3.0)			91 (3.6)			
	Min. spindle indexing angle (C1-axis)	deg	0.0001						
Right spindle	Max. spindle speed	r/min	-	5000		-	5000		
	Spindle motor power (S3 25%/cont.)	kW	-	22 / 22 / 18.5 / 15		-	22 / 22 / 18.5 / 15		
	Spindle nose	ASA	-	A2-6		-	A2-6		
	Spindle bearing diameter (Front)	mm	-	110 (4.3)		-	110 (4.3)		
	Spindle through hole	mm	-	76 (3.0)		-	76 (3.0)		
	Min. spindle indexing angle (C2-axis)	deg	-	0.001{0.0001}		-	0.001{0.0001}		
Milling spindle	Max. spindle speed	r/min	12000						
	Milling spindle motor power (2.5min/10min/Cont.)	kW	22 / 22 / 18.5 / 15 (29.5 / 29.5 / 24.8 / 20.1)						
	Min. spindle indexing angle (B-axis)	deg.	0.0001						
Automatic tool changer	Tool storage capa. (Max.)	ea	40 {80,120}						
	Tool shank	-	CAPTO C6						
	Max. tool diameter continuous	mm (inch)	90 (3.5)						
	Max. tool diameter without adjacent tools	mm (inch)	130 (5.1)						
	Max. tool length	mm (inch)	300 (11.8)						
	Max. tool weight	kg (lb)	12 (26.5)						
	Max. tool moment	N · m (ft-lbs)	9.8 (7.2)						
	Tool change time (T-T-T)	Tool-to-tool	sec	1.8					
		Chip-to-chip	sec	7.8					
Lower turret	No. of tool stations	ea	-	12{24 position index}		-	12{24 position index}		
	OD tool size	mm (inch)	-	25 (1.0)		-	25 (1.0)		
	Max. boring bar size	mm (inch)	-	Ø40 (Ø1.6)		-	Ø40 (Ø1.6)		
	Turret Indexing time (1 station swivel)	s	-	0.2		-	0.2		
	Max. rotary tool speed	r/min	-	{5000, 10000}		-	{5000, 10000}		
Long boring bar magazine (option for SMX 3100L/LS)	Tool storage capacity (Max.)	ea	-						
	Max. tool size	mm (inch)	-						
	Max. tool weight	kg (lb)	-						
Tail stock	Quill bore taper	MT	#4		#4		-		
	Quill travel	mm (inch)	1075 (42.3)	-		1075 (42.3)		-	
Coolant	Coolant pump motor power	kW (Hp)	1.1						
Power source	Electric power supply (rated capacity)	kVA	55.04	73.53	80.19	51.74	70.24	76.9	
	Height	mm (inch)	2777 (109.3)						
Machine dimensions	Length	mm (inch)	3950 (155.5) (without Chip Conveyor), 4845 (190.7)						
	Width	mm (inch)	2770 (109.1) (without Chip Conveyor), 2770 (109.1)						
	Weight	kg (lb)	14900 (32848.4)	15200 (33509.8)	15800 (34832.5)	15000 (33068.9)	15300 (33730.2)	15900 (35053.0)	
Control	NC system	Fanuc 31i plus{Fanuc 31i-5 plus / Siemens 840D / CUFOS}							

MACHINE SPECIFICATIONS

SMX 2600 series

Item	Unit	SMX 2600	SMX 2600S	SMX 2600ST		
Capacity	Swing over bed	mm (inch)	660 (26.0)			
	Recom. turning diameter	mm (inch)	255 (10.0)			
	Max. turning diameter	mm (inch)	660 (26.0)	660 (26.0) [Lower turret : 405 (15.9)]		
	Max. turning length	mm (inch)	1540 (60.6)			
	Chuck size	Left spindle	inch	10 {12}*		
		Right spindle	inch	-	10 {12}*	
	Chuck work weight (include chuck)	kg (lb)	260 (573.2)			
	Shaft work weight (include chuck)	kg (lb)	520 (1146.4)			
Bar working diameter	mm (inch)	81 (3.2)				
Travels	Travel distance	X-axis	mm (inch)	630 (24.8)	695 (27.4)	
		Y-axis	mm (inch)	300 (±150) (11.8 (±5.9))		
		Z-axis	mm (inch)	1585 (62.4)		
		A-axis**	mm (inch)	1562 (61.5)	1605 (63.2)	1540 (60.6)
		B-axis	deg	240 (±120)		
		C1-axis / C2-axis	deg	360 / 360		
	Rapid traverse rate	X2-axis / Z2-axis	mm (inch)	-	-	235 / 1540 (9.3 / 60.6)
		X-axis	m/min (ipm)	48 (1889.8)		
		Y-axis	m/min (ipm)	36 (1417.3)		
		Z-axis	m/min (ipm)	48 (1889.8)		
		A-axis**	m/min (ipm)	-	30 (1181.1)	
		B-axis	r/min	40		
		C1-axis / C2-axis	r/min	200 / 200		
		X2-axis / Z2-axis	m/min (ipm)	-	-	24 / 36 (944.9 / 1417.3)
Left spindle	Max. spindle speed	r/min	4000			
	Spindle motor power (S3 25%/cont.)	kW (Hp)	30/26/22 (40.2/34./29.5) (S3 25% / S2 30min / S1 Cont.)			
	Spindle nose		ASA			
	Spindle bearing diameter (Front)	mm (inch)	130 (5.1)			
	Spindle through hole	mm (inch)	91 (3.6)			
	Min. spindle indexing angle (C1-axis)	deg	0.0001			
Right spindle	Max. spindle speed	r/min	-	4000		
	Spindle motor power (S3 25%/cont.)	kW (Hp)	-	30/26/22 (40.2/34./29.5) (S3 25% / S2 30min / S1 Cont.)		
	Spindle nose		-	A2-8		
	Spindle bearing diameter (Front)	mm (inch)	-	130 (5.1)		
	Spindle through hole	mm (inch)	-	91 (3.6)		
	Min. spindle indexing angle (C2-axis)	deg	-	0.001		
Milling spindle	Max. spindle speed	r/min	12000 {8000}*			
	Milling spindle motor power (2.5min/10min/Cont.)	kW (Hp)	26/18.5/15 (34.9/24.8/20.1)			
	Min. spindle indexing angle (B-axis)	deg	0.0001			
Automatic tool changer	Tool storage capa. (Max.)	ea	40 {80/120}*			
	Tool shank		CAPTO C6 {HSK-T63}*			
	Max. tool diameter continuous	mm (inch)	90 (3.5)			
	Max. tool diameter without adjacent tools	mm (inch)	130 (5.1)			
	Max. tool length	mm (inch)	450 (17.7)			
	Max. tool weight	kg (lb)	12 (26.5)			
	Max. tool moment		N · m (ft-lbs)	9.8 (7.2)		
		Tool change time (T-T)	Tool-to-tool	1.8		
	Chip-to-chip	7.8				
Lower turret	No. of tool stations	ea	-	12		
	OD tool size	mm (inch)	-	25 (1.0)		
	Max. boring bar size	mm (inch)	-	40 (1.6)		
	Turret Indexing time (1 station swivel)	s	-	0.2		
	Max. rotary tool speed	r/min	-	5000		
Long boring bar magazine (option for SMX 3100L/LS)	Tool storage capacity (Max.)	ea	-	-		
	Max. tool size	mm (inch)	-	-		
	Max. tool weight	kg (lb)	-	-		
Tail stock	Quill bore taper	MT	#5	-		
	Quill travel	mm (inch)	1562 (61.5)	-		
Coolant	Coolant pump motor power	kW (Hp)	2.2 (3.0)			
Power source	Electric power supply (rated capacity)	kVA	68.64	92.84	98.93	
Machine dimensions	Height	mm (inch)	2750 (108.3)	2750 (108.3)	2820 (111.0)	
	Length	mm (inch)	4900 (192.9)	4900 (192.9)	4900 (192.9)	
	Width	mm (inch)	3011 (118.5)	3011 (118.5)	3021 (118.9)	
	Weight	kg (lb)	15800 (34832.5)	16200 (35714.4)	18000 (39682.6)	
Control	NC system	FANUC31i {FANUC31i-5 / SIEMENS 840D / CUFOS}*				

* { } : Optimal ** A-axis is travel of servo tail stock in PUMA SXM2600, 3100/L and travel of right spindle in SMX 2600S/ST, 3100S/ST/LS.

MACHINE SPECIFICATIONS

SMX 3100 series

Item	Unit	SMX 3100	SMX 3100L	SMX 3100S	SMX 3100ST	SMX 3100LS		
Capacity	Swing over bed	mm (inch)			660 (26.0)			
	Recom. turning diameter	mm (inch)			315 (12.4)			
	Max. turning diameter	mm (inch)		660 (26.0)		660 (26.0) [Lower turret : 405 (15.9)]		
	Max. turning length	mm (inch)	1540 (60.6)	2540 (100.0)	1540 (60.6)	2540 (100.0)		
	Chuck size	inch			12 {15}* Right spindle	10 {12}* Left spindle		
	Chuck work weight (include chuck)	kg (lb)			500 (1102.3)			
	Shaft work weight (include chuck)	kg (lb)			1000 (2204.6)			
	Bar working diameter	mm (inch)			102 (4.0)			
Travels	Travel distance	X-axis	mm (inch)	630 (24.8)		695 (27.4)	630 (24.8)	
		Y-axis	mm (inch)					
		Z-axis	mm (inch)		2585 (101.8)	1585 (62.4)	2585 (101.8)	
		A-axis**	mm (inch)	1562 (61.5)	2500 (98.4)	1605 (63.2)	1540 (60.6)	2500 (98.4)
		B-axis	deg					
		C1-axis / C2-axis	deg					
	Rapid traverse rate	X2-axis / Z2-axis	mm (inch)	-	-	-	235 / 1540 (9.3 / 60.6)	-
		X-axis	m/min (ipm)			48 (1889.8)		
		Y-axis	m/min (ipm)			36 (1417.3)		
		Z-axis	m/min (ipm)	48 (1889.8)	30 (1181.1)	48 (1889.8)		30 (1181.1)
		A-axis**	m/min (ipm)	-	-	30 (1181.1)		
		B-axis	r/min			40		
		C1-axis / C2-axis	r/min			200 / 200		
		X2-axis / Z2-axis	m/min (ipm)	-	-	-	24 / 36 (944.9 / 1417.3)	-
Left spindle	Max. spindle speed	r/min			3000			
	Spindle motor power	kW (Hp)			30/25 (40.2/33.5) (S2 30min/S1 Cont.)			
	Spindle nose	ASA			A2-11			
	Spindle bearing diameter (Front)	mm (inch)			160 (6.3)			
	Spindle through hole	mm (inch)			115 (4.5)			
	Min. spindle indexing angle (C1-axis)	deg			0.0001			
Right spindle	Max. spindle speed	r/min	-	-	4000			
	Spindle motor power	kW (Hp)	-	-	30/25 (40.2/33.5) (S2 30min/S1 Cont.)			
	Spindle nose	ASA	-	-	A2-8			
	Spindle bearing diameter (Front)	mm (inch)	-	-	130 (5.1)			
	Spindle through hole	mm (inch)	-	-	91 (3.6)			
	Min. spindle indexing angle (C2-axis)	deg	-	-	0.001			
Milling spindle	Max. spindle speed	r/min			12000 {8000}* Milling spindle motor power (2.5min/10min/Cont.)			
	Milling spindle motor power (2.5min/10min/Cont.)	kW (Hp)			26/18.5/15 (34.9/24.8/20.1)			
	Min. spindle indexing angle (B-axis)	deg						
Automatic tool changer	Tool storage capa. (Max.)	ea			40 {80/120}* Tool shank			
	Tool shank	-			CAPTO C6 {HSK-T63}* Max. tool diameter continuous			
	Max. tool diameter continuous	mm (inch)			90 (3.5)			
	Max. tool diameter without adjacent tools	mm (inch)			130 (5.1)			
	Max. tool length	mm (inch)			450 (17.7)			
	Max. tool weight	kg (lb)			12 (26.5)			
	Max. tool moment	N · m (ft-lbs)			9.8 (7.2)			
	Tool change time (T-T)	sec			1.8 Chip-to-chip			
Lower turret	No. of tool stations	ea			12	-		
	OD tool size	mm (inch)			25 (1.0)	-		
	Max. boring bar size	mm (inch)			40 (1.6)	-		
	Turret Indexing time (1 station swivel)	s			0.2	-		
	Max. rotary tool speed	r/min			5000	-		
Long boring bar magazine (option for SMX 3100L/LS)	Tool storage capacity (Max.)	ea	-	{3}* Max. tool size	-	{3}* {Ø60 x L600 or Ø30 x L800 (Ø2.4 x L23.6 or Ø1.2 x L31.5)}*		
	Max. tool size	mm (inch)	-	{Ø60 x L600 or Ø30 x L800 (Ø2.4 x L23.6 or Ø1.2 x L31.5)}*	-	{Ø60 x L600 or Ø30 x L800 (Ø2.4 x L23.6 or Ø1.2 x L31.5)}*		
	Max. tool weight	kg (lb)	-	{15}* Tail Stock	-	{15}* Quill bore taper		
Tail Stock	Quill bore taper	MT	#5	#5	-	-		
	Quill travel	mm (inch)	1562 (61.5)	2500 (98.4)	-	-		
Coolant	Coolant pump motor power	kW (Hp)			2.2 (3.0)			
Power source	Electric power supply (rated capacity)	kVA	69.78	69.80	99.44	99.46		
	Height	mm (inch)	2750 (108.3)	2850 (112.2)	2850 (112.2)	2820 (111.0)		
Machine dimensions	Length	mm (inch)	4900 (192.9)	6400 (252.0)	4900 (192.9)	4900 (192.9)		
	Width	mm (inch)	3011 (118.5)	3011 (118.5)	3011 (118.5)	3021 (118.9)		
	Weight	kg (lb)	16300 (35934.8)	20100 (44312.3)	16700 (36816.7)	18500 (40784.9)		
Control	NC system				FANUC31i {FANUC31i-5 / SIEMENS 840D / CUFOS}* 20500 (45194.1)			

*{ } : Optimal ** A-axis is travel of servo tail stock in PUMA SXM2600, 3100/L and travel of right spindle in SMX 2600S/ST, 3100S/ST/LS.

The DN Solutions promise, MACHINE GREATNESS, has two important meanings. The first is simple: DN Solutions makes great machines. The second is a challenge to our end-users. With a product line that is this comprehensive, accurate and reliable, we equip our customers to machine greatness. **The big question: *Why should you choose DN Solutions over other options?***

Here's why...



**MACHINE
GREATNESS™**



WHAT YOU MAKE AND HOW YOU MAKE IT MATTERS—SO MAKE IT
GREAT WITH DN SOLUTIONS.

UNBEATABLE MACHINES

You won't find a more comprehensive range or a better combination of value, performance and reliability anywhere else.

ROBUST PRODUCT LINE

We offer an impressive range of machine models and hundreds of configurations. Whatever your machining needs and requirements, there's a DN Solutions for you.

READILY AVAILABLE - ANYWHERE IN THE WORLD

Machining centres (including 5-axis machines), lathes, multi-tasking turning centres and mill-turn machines, and horizontal borers with best-in-class specifications are all available...ready to install.

EXPERT SERVICE

Our dedicated, experienced and knowledgeable team is totally committed to improving your productivity, growth and success.

RESPONDING TO CUSTOMERS ANYTIME, ANYWHERE

DN Solutions Global Network

DN Solutions provides systems-based professional support services, before and after the machine tool sale, by responding quickly and efficiently to customers. By supplying spare parts, product training, field service and technical support, we provide the expert care, attention and assistance our customers expect from a market leader.

Global sales and service support network		51	Technical centers Technical center, Sales support, Service support, Parts support
4	Corporations	200	Service posts
156	Dealer networks	3	Factories



CUSTOMER SUPPORT AND SERVICES

We're there for you whenever you need us.

We help our customers operate at maximum efficiency by providing them with a range of tried, tested and trusted services - from pre-sales consultancy to post-sales support.



Field services

- On-site service
- Machine installation and testing
- Scheduled preventive maintenance
- Machine repair service



Parts supply

- Supplying a wide range of original DN Solutions spare parts
- Parts repair service



Training

- Programming, machine setup and operation
- Electrical and mechanical maintenance
- Applications engineering



Technical support

- Supports machining methods and technology
- Responds to technical queries
- Provides technical consultancy



dn-solutions.com

Head Office

22F T Tower, 30, Sowol-ro 2-gil
Jung-gu, Seoul, Korea, 04637

Tel: +82-2-6972-0370/0350
Fax: +82-2-6972-0400

DN Solutions America

19A Chapin Road, Pine Brook
New Jersey 07058, United States

Tel: +1-973-618-2500
Fax: +1-973-618-2501

DN Solutions Europe

Emdener Strasse 24, D-41540
Dormagen, Germany

Tel: +49-2133-5067-100
Fax: +49-2133-5067-111

DN Solutions India

No.82, Jakkuar Village
Yelahanka Hobli, Bangalore-560064

Tel: + 91-80-2205-6900
E-mail: india@dncompany.com

DN Solutions China

Room 101,201,301, Building 39 Xinzhuan
Highway No.258 Songjiang District
China Shanghai (201612)

Tel: +86 21-5445-1155
Fax: +86 21-6405-1472

Sales inquiry

sales@dncompany.com

* For more details, please contact DN Solutions.

* Specifications and information contained within this catalogue may be changed without prior notice.